



Climax Metal Products Company

8141 Tyler Boulevard
Mentor, Ohio 44060
USA

Toll free: 800-542-6552

Phone: 440-585-0300

Fax: 800-860-5553

Email: sales@climaxmetal.com

Website: www.climaxmetal.com

ITEM # 2C-137, TWO-PIECE, CLAMPING COLLAR- 2C-SERIES

Black Oxide Plated Steel Two-Piece Clamping Collar. Design fully engages the shaft without marring. Easily installed where major disassembly would otherwise be required. Greater axial holding power than set screw or one-piece clamping collars. Effective on hard & soft shafts.



[Drawing](#) | [Specifications](#) | [Regulation & Compliance](#)

Drawing

Dimensional Drawing

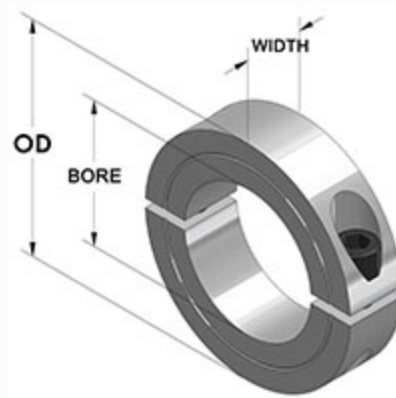

Two-Piece Clamping Collar

Need Help?

Specifications

Bore	1 3/8 in
OD	2 1/4 in
Width	9/16 in
Style	Two-Piece Clamp
Material	Steel, ASTM A108
Finish	Black Oxide
Clamp Screw	Hex Socket Cap Screw, 3A Thread, Steel, ASTM A574: 1/4-28 x 3/4
Recessed Screw	No
Approximate Weight	5.70 oz
UPC Code	044861221280
Downloads	Catalog Page

Regulation & Compliance

[REACH Compliance Statement](#)

[RoHS 3 Compliance Statement](#)

[Disclosure of Conflict Minerals and Materials](#)

[California Propostion 65 Warning](#)

[Toxic Substances Control Act TSCA](#)

[DFARS Compliance Statement](#)

[Safety Data Sheet](#)

[ISO Certificate](#)

