

**SD542**

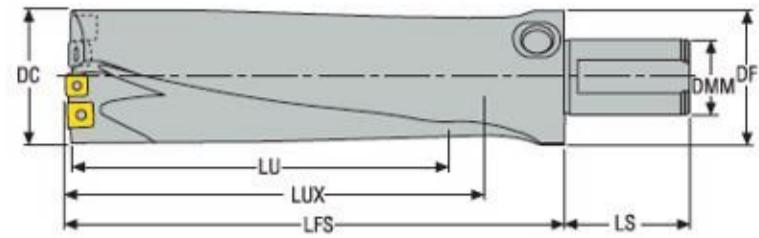



Drilling depth ~ 2.5 X D – Inch



- ISO 9766 shank, -7
- Internal coolant
- For insert information see page(s) 294–297
- For cutting data see page(s) 306, 307
- For intermediate diameters see the MyDesign

Designation	Item number	DC	LU	OAL	LUX	LFS	LS	DMM	DF	Insert	
										Center insert	Periph insert
		Inch	Inch	Inch	Inch	Inch	Inch	Inch	Inch		
SD542-2250-563-1500R7	02602085	2.250	5.630	11.500	5.800	7.000	4.500	1.500	3.110	SPGX 0903-C1	SCGX 09T308..
SD542-2500-625-1500R7	02602087	2.500	6.250	12.780	6.520	8.280	4.500	1.500	3.110	SPGX 0903-C1	SCGX 09T308..
SD542-2750-688-1500R7	02602088	2.750	6.880	13.400	7.190	8.900	4.500	1.500	3.110	SPGX 11T3-C1	SCGX 120408..
SD542-3000-750-2000R7	02602089	3.000	7.500	14.030	7.860	9.530	4.500	2.000	3.110	SPGX 11T3-C1	SCGX 120408..
SD542-3250-813-2500R7	02602090	3.250	8.130	14.650	8.460	10.150	4.500	2.500	3.500	SPGX 12T3-C1	SCGX 120408..
SD542-3500-875-2500R7	02602091	3.500	8.750	15.280	9.140	10.780	4.500	2.500	3.500	SPGX 1504-C1	SCGX 120408..

**Spare Parts, included in delivery**

For drill dia. (inch)	Hose adapter	Insert key	Insert screw centre	Insert screw periph	Screw
					
2.250-2.500	R3/8-HA	T09P-2	C03007-T09P	C03009-T09P	R3/8
2.750-3.250	R3/8-HA	T15P-2D	C03508-T15P	C05012-T15P	R3/8
3.500	R3/8-HA	T15P-2D	C04011-T15P	C05012-T15P	R3/8

**Accessories**

For drill dia. (inch)	Torque key
	
2.250-2.500	T00-09P20
2.750-3.250	T00-15P30
3.500	T00-15P30

Introduction

Drilling

Reaming

Boring

Annex

### SD572



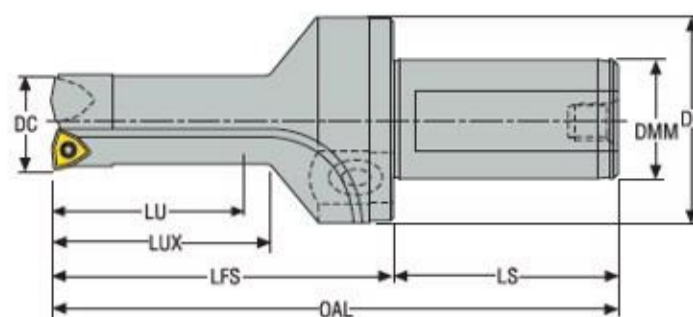



Drilling depth ~ 2 X D – Metric



- ISO 9766 shank, -7
- Internal coolant
- For insert information see page(s) 294-297
- For cutting data see page(s) 308-309
- For intermediate diameters see the MyDesign

Designation	Item number	Hole dia min-max mm	DC	LU	LUX	LFS	LS	DMM	DF	Insert	
										Center insert	Periph insert
SD572-15-30-25R7	02595777	14,8 -18	15,0	30,0	35,0	65,0	56,0	25,0	42,0	WCMX030208-86	WCMX030208..
SD572-16-32-25R7	02595778	15,8 -18	16,0	32,0	37,0	67,0	56,0	25,0	42,0	WCMX030208-86	WCMX030208..
SD572-17-34-25R7	02595779	16,8 -19	17,0	34,0	39,0	69,0	56,0	25,0	42,0	WCMX030208-86	WCMX030208..
SD572-19-38-25R7	02595780	18,8 -22	19,0	38,0	43,0	73,0	56,0	25,0	42,0	WCMX040208-86	WCMX030208..
SD572-22-44-25R7	02595781	21,8 -27	22,0	44,0	49,0	79,0	56,0	25,0	42,0	WCMX050308-86	WCMX040208..
SD572-27-54-32R7	02595783	26,8 -33	27,0	54,0	59,0	89,0	60,0	32,0	50,0	WCMX06T308-86	WCMX050308..
SD572-33-66-40R7	02595784	32,8 -41	33,0	66,0	71,0	101,0	68,0	40,0	59,0	WCMX080412-86	WCMX06T308..
SD572-41-82-40R7	02595785	40,8 -47	41,0	82,0	87,0	117,0	68,0	40,0	59,0	WCMX080412-86	WCMX080412..
SD572-47-94-40R7	02595786	46,8 -52	47,0	94,0	99,0	129,0	68,0	40,0	59,0	WCMX080412-86	WCMX080412..

### Spare Parts, included in delivery

Designation	Hose adapter	Insert key	Insert screw centre	Insert screw periph	Key (Flag)	Screw
						
SD572-15-30-25R7	1310	T07P-2	C02205-T07P	C02205-T07P	-	R1/4
SD572-16-32-25R7	1310	T07P-2	C02205-T07P	C02205-T07P	-	R1/4
SD572-17-34-25R7	1310	T07P-2	C02205-T07P	C02205-T07P	-	R1/4
SD572-19-38-25R7	1310	T07P-2	C02205-T07P	C02205-T07P	-	R1/4
SD572-22-44-25R7	1310	T08P-2	C02506-T08P	C03007-T08P	-	R1/4
SD572-27-54-32R7	1310	T08P-2	C03508-T15P	C03007-T08P	T15P-2D	R1/4
SD572-33-66-40R7	1310	T15P-2D	C03508-T15	C03508-T15P	-	R1/4
SD572-41-82-40R7	1310	T15P-2D	C04011-T15P	C04011-T15P	-	R1/4
SD572-47-94-40R7	1310	T15P-2D	C04011-T15P	C04011-T15P	-	R1/4