

SIEMENS



Motion Control Drives











# SINAMICS V90 Basic Servo Drive System

Catalog  
D 33

Edition  
May  
2019

[siemens.com/drives](https://www.siemens.com/drives)

## Related catalogs

<p><b>Motion Control Drives</b> D 31.1 SINAMICS Inverters for Single-Axis Drives Built-In Units</p> <p>E86060-K5531-A111-A1-7600</p>		<p><b>Industrial Controls</b> IC 10 SIRIUS</p> <p>PDF (E86060-K1010-A101-A9-7600)</p>	
<p><b>Motion Control Drives</b> D 31.5 SINAMICS Converters for Single-Axis Drives SINAMICS G120X infrastructure converters for HVAC/Water/Wastewater</p> <p>PDF (E86060-K5531-A151-A1-7600)</p>		<p><b>Industrial Controls</b> IC 10 AO SIRIUS Classic</p> <p>PDF (E86060-K1010-A191-A5-7600)</p>	
<p><b>SINAMICS S120</b> D 21.3 Chassis Format Converter Units Cabinet Modules</p> <p><b>SINAMICS S150</b> Converter Cabinet Units E86060-K5521-A131-A6-7600</p>		<p><b>Low-Voltage Power Distribution and Electrical Installation Technology</b> LV 10 SENTRON • SIVACON • ALPHA Protection, Switching, Measuring and Monitoring Devices, Switchboards and Distribution Systems PDF (E86060-K8280-A101-A8-7600) Print (E86060-K8280-A101-A6-7600)</p>	
<p><b>Motion Control Drives</b> D 21.4 SINAMICS S120 and SIMOTICS</p> <p>E86060-K5521-A141-A1-7600</p>		<p><b>SIMATIC</b> ST 70 Products for Totally Integrated Automation</p> <p>PDF (E86060-K4670-A101-B7-7600)</p>	
<p><b>SIMOTICS S-1FG1</b> D 41 <b>Servo geared motors</b> Helical, Parallel shaft, Bevel and Helical worm geared motors</p> <p>PDF (E86060-K5541-A101-A4-7600)</p>		<p><b>SIMATIC HMI / PC-based Automation</b> ST 80/ST PC Human Machine Interface Systems PC-based Automation</p> <p>E86060-K4680-A101-C6-7600</p>	
<p><b>SIMOTICS GP, SD, XP, DP</b> D 81.1 <b>Low-Voltage Motors</b> Type series 1FP1, 1LE1, 1LE5, 1MB1 and 1PC1 Frame sizes 63 to 355 Power range 0.09 to 500 kW E86060-K5581-A111-B2-7600</p>		<p><b>Industrial Communication</b> IK PI SIMATIC NET</p> <p>E86060-K6710-A101-B8-7600</p>	
<p><b>FLENDER Couplings</b> MD 10.1 Standard Couplings</p> <p>E86060-K5710-A111-A5-7600</p>		<p><b>SITRAIN</b> Training for Industry</p> <p><a href="http://www.siemens.com/sitrain">www.siemens.com/sitrain</a></p>	
<p><b>SIMOGEAR</b> MD 50.1 <b>Geared Motors</b> Helical, parallel shaft, bevel, helical worm and worm geared motors</p> <p>E86060-K5250-A111-A5-7600</p>		<p><b>Products for Automation and Drives</b> CA 01 Interactive Catalog Download</p> <p><a href="http://www.siemens.com/ca01download">www.siemens.com/ca01download</a></p>	
<p><b>Motion Control System</b> PM 21 SIMOTION Equipment for Production Machines</p> <p>E86060-K4921-A101-A4-7600</p>		<p><b>Industry Mall</b> Information and Ordering Platform on the Internet:</p> <p><a href="http://www.siemens.com/industrymall">www.siemens.com/industrymall</a></p>	



**SIEMENS**

# SINAMICS V90

## Basic Servo Drive System

### Motion Control Drives

Catalog D 33 · May 2019

Dear Customer,

We are pleased to present you with the new edition for Catalog D 33 · May 2019. The catalog provides a comprehensive overview of the SINAMICS V90 basic servo drive system consisting of a SINAMICS V90 servo drive, a SIMOTICS S-1FL6 servomotor and a matching MOTION-CONNECT connection system.

The products listed in this catalog are also included in the Industry Mall.  
Please contact your local Siemens office for additional information.

NEW: The WEB PDF enables the direct jump into the Industry Mall with further information incl. online order by clicking on an article number.

Up-to-date information about SINAMICS V90 is available online at  
[www.siemens.com/sinamics-v90](http://www.siemens.com/sinamics-v90)

You can access our Interactive Catalog and our Industry Mall online at  
[www.siemens.com/industrymall](http://www.siemens.com/industrymall)

Your personal contact is keen to receive your suggestions and recommendations for improvement. You can find your contact in our contact database at  
[www.siemens.com/automation-contact](http://www.siemens.com/automation-contact)

We hope that you will often enjoy using Catalog D 33 · May 2019 as a selection and ordering reference document and wish you every success with our products and solutions.

With kind regards,



Achim Peltz  
Vice President  
General Motion Control  
Siemens AG, Digital Industries, Motion Control





# SINAMICS V90 Basic Servo Drive System

## Motion Control Drives



### Catalog D 33 · May 2019

Refer to the Industry Mall for current updates of this catalog:

[www.siemens.com/industrymall](http://www.siemens.com/industrymall)

The products contained in this catalog can also be found in the Interactive Catalog CA 01.

[www.siemens.com/ca01download](http://www.siemens.com/ca01download)

Please contact your local Siemens branch.

### NEW

Click on an Article No. in the catalog PDF to call it up in the Industry Mall and to obtain all the information.

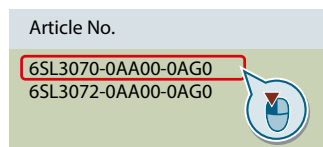

Or directly on the Internet, e.g.

[www.siemens.com/product?6SL3070-0AA00-0AG0](http://www.siemens.com/product?6SL3070-0AA00-0AG0)



The products and systems described in this catalog are manufactured/distributed under application of a certified quality management system in accordance with EN ISO 9001. The certificate is recognized by all IQNet countries.

## System overview

1

## SINAMICS V90 servo drive

2

## SIMOTICS S-1FL6 servomotors

3

## MOTION-CONNECT connection systems

4

## Engineering tools

5

## Services and documentation

6

## Appendix

7

# Digital Enterprise

## The building blocks that ensure everything works together perfectly in the digital enterprise

Digitalization is already changing all areas of life and existing business models. It is placing greater pressure on industry while at the same time creating new business opportunities. Today, thanks to scalable solutions from Siemens, companies can already become a digital enterprise and ensure their competitiveness.



### Industry faces tremendous challenges



#### Reduce time-to-market

Today manufacturers have to bring products to market at an ever-increasing pace despite the growing complexity of these products. In the past, a major manufacturer would push aside a small one, but now it is a fast manufacturer that overtakes a slow one.



#### Boost flexibility

Consumers want customized products, but at a price they would pay for a mass-produced item. That only works if production is more flexible than ever before.



#### Improve quality

To ensure a high level of quality while meeting legal requirements, companies have to establish closed quality loops and enable the traceability of products.

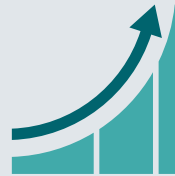

#### Boost efficiency

Today the product itself needs to be sustainable and environmentally friendly, while energy efficiency in production has become a competitive advantage.



#### Increase security

Increasing networking escalates the threat to production facilities of cyberattacks. Today more than ever, companies need suitable security measures.



## The digital enterprise has already become a reality

To fully benefit from all the advantages of digitalization, companies first have to achieve complete consistency of their data. Fully digitally integrated business processes, including those of suppliers, can help to create a digital representation of the entire value chain. This requires

- the integration of industrial software and automation,
- expansion of the communication networks,
- security in automation,
- and the use of business-specific industrial services.

## MindSphere

### The cloud-based open IoT operating system from Siemens

With MindSphere, Siemens offers a cost-effective and scalable cloud platform as a service (PaaS) for the development of applications. The platform, designed as an open operating system for the Internet of Things, makes it possible to improve the efficiency of plants by collecting and analyzing large volumes of production data.

### Totally Integrated Automation (TIA) Where digitalization becomes reality

Totally Integrated Automation (TIA) ensures the seamless transition from the virtual to the real world. It already encompasses all the necessary conditions for transforming the benefits of digitalization into true added value. The data that will form the digital twin for actual production is generated from a common base.

### Digital Plant

Learn more about the digital enterprise for the process industry  
[www.siemens.com/digitalplant](http://www.siemens.com/digitalplant)

### Digital Enterprise Suite

Learn more about the digital enterprise for the discrete industry  
[www.siemens.com/digital-enterprise-suite](http://www.siemens.com/digital-enterprise-suite)



# Integrated Drive Systems

Faster on the market and in the black with Integrated Drive Systems

Integrated Drive Systems are Siemens' trendsetting answer to the high degree of complexity that characterizes drive and automation technology today. The world's only true one-stop solution for entire drive systems is characterized in particular by its threefold integration: Horizontal, vertical, and lifecycle integration ensure that every drive system component fits seamlessly into the whole system, into any automation environment, and even into the entire lifecycle of a plant.

The outcome is an optimal workflow – from engineering all the way to service that entails more productivity, increased efficiency, and better availability. That's how Integrated Drive Systems reduce time to market and time to profit.

## Horizontal integration

**Integrated drive portfolio:** The core elements of a fully integrated drive portfolio are frequency converters, motors, couplings, and gear units. At Siemens, they're all available from a single source. Perfectly integrated, perfectly interacting. For all power and performance classes. As standard solutions or fully customized. No other player in the market can offer a comparable portfolio. Moreover, all Siemens drive components are perfectly matched, so they are optimally interacting.

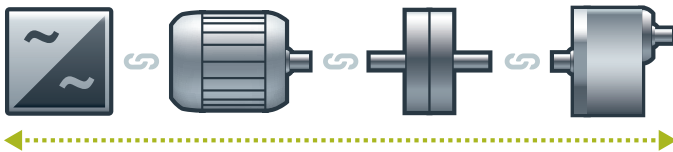

You can boost the availability of your application or plant to up to



## Vertical integration

Thanks to **vertical integration**, the complete drive train is seamlessly integrated in the entire automation environment – an important prerequisite for production with maximum value added. Integrated Drive Systems are part of Totally Integrated Automation (TIA), which means that they are perfectly embedded into the system architecture of the entire industrial production process. This enables optimal processes through maximum communication and control.

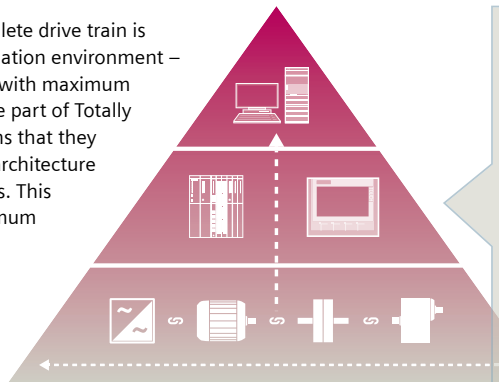

With TIA Portal you can cut your engineering time by up to



## Lifecycle integration

**Lifecycle integration** adds the factor of time: Software and service are available for the entire lifecycle of an Integrated Drive System. That way, important optimization potential for maximum productivity, increased efficiency, and highest availability can be leveraged throughout the system's lifecycle – from planning, design, and engineering to operation, maintenance, and all the way even to modernization.

With Integrated Drive Systems, assets become important success factors. They ensure shorter time to market, maximum productivity and efficiency in operation, and shorter time to profit.

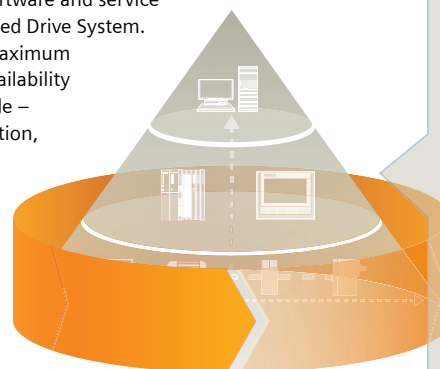

With Integrated Drive Systems you can reduce your maintenance costs by up to



## System overview



<b>1/2</b>	<b>The SINAMICS drive family</b>
1/2	Overview
<b>1/6</b>	<b>Drive selection</b>
1/6	Overview
1/6	More information
<b>1/7</b>	<b>SINAMICS V90 basic servo drive system</b>
1/7	Overview
1/7	Benefits
1/8	Application
1/9	Design
1/10	Selection and ordering data
1/14	Accessories
1/15	Function
1/16	Configuration
1/16	Technical specifications
1/16	More information
1/17	Integration
<b>1/20</b>	<b>SINAMICS V90 Starter Kit</b>
1/20	Overview
1/20	Benefits
1/20	Selection and ordering data
<b>1/21</b>	<b>Recommended SIMATIC S7 controller</b>
1/21	Selection and ordering data

# System overview

## The SINAMICS drive family

### Overview

#### Integration in automation

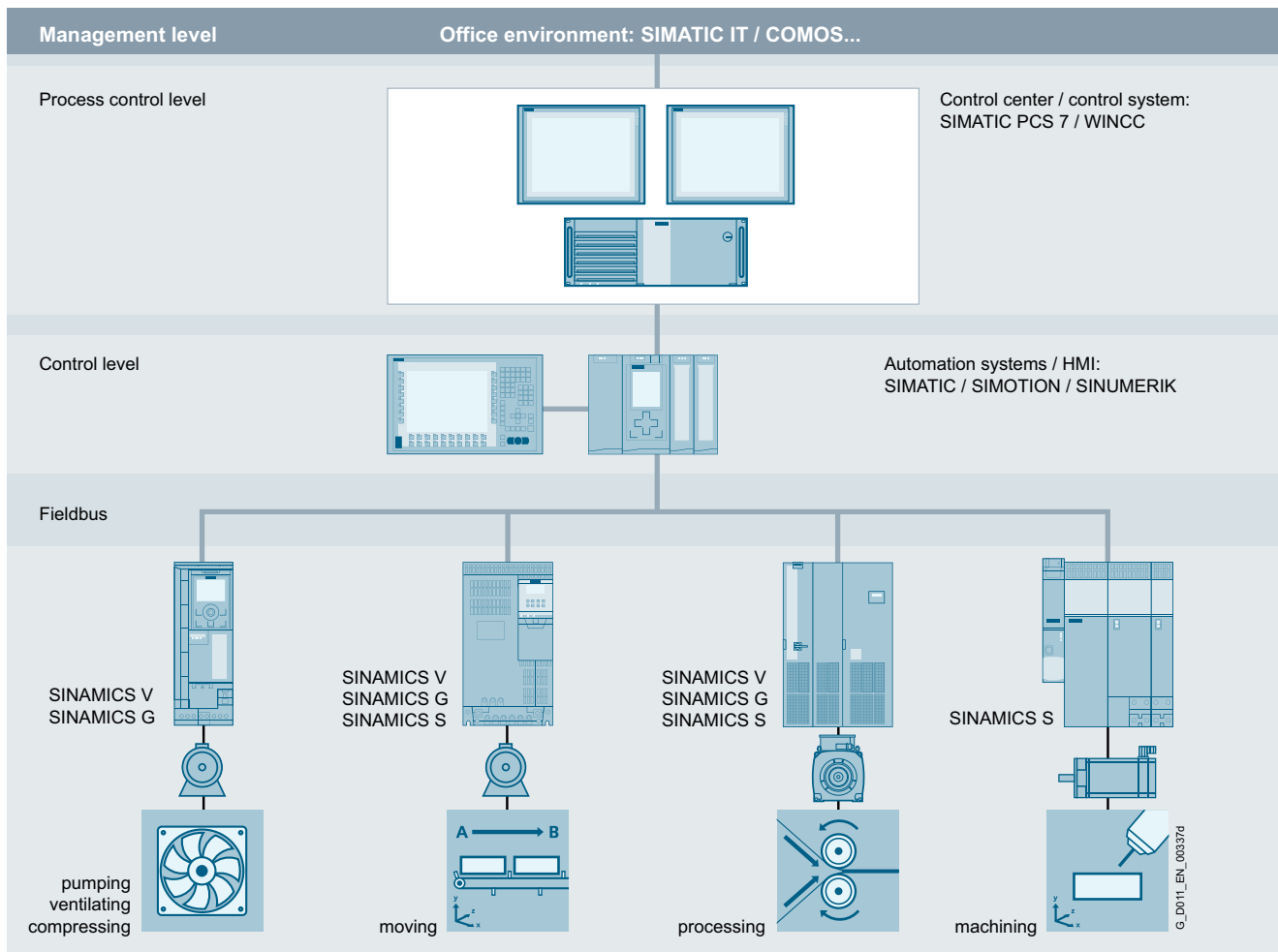

#### Totally Integrated Automation and communication

SINAMICS is an integral component of the Siemens "Totally Integrated Automation" concept. Integrated SINAMICS systems covering configuration, data storage, and communication at automation level ensure low-maintenance solutions with the SIMATIC, SIMOTION and SINUMERIK control systems.

Depending on the application, the appropriate variable frequency drives can be selected and incorporated in the automation concept. With this in mind, the drives are clearly subdivided into their different applications. A wide range of communication options (depending on the drive type) are available for establishing a communication link to the automation system:

- PROFINET
- PROFIBUS
- EtherNet/IP
- Modbus TCP
- Modbus RTU
- AS-Interface
- BACnet MS/TP

#### Applications

SINAMICS is the comprehensive family of drives from Siemens designed for machine and plant engineering applications. SINAMICS offers solutions for all drive tasks:

- Simple pump and fan applications in the process industry
- Demanding single drives in centrifuges, presses, extruders, elevators, as well as conveyor and transport systems
- Drive line-ups in textile, plastic film, and paper machines as well as in rolling mill plants
- Highly dynamic servo drives for machine tools, as well as packaging and printing machines



**Overview** (continued)*SINAMICS as part of the Siemens modular automation system****Innovative, energy-efficient and reliable drive systems and applications as well as services for the entire drive train***

The solutions for drive technology place great emphasis on the highest productivity, energy efficiency and reliability for all torque ranges, performance and voltage classes.

Siemens offers not only the right innovative variable frequency drive for every drive application, but also a wide range of energy-efficient low voltage motors, geared motors, explosion-protected motors and high-voltage motors for combination with SINAMICS.

Furthermore, Siemens supports its customers with global pre-sales and after-sales services, with over 295 service points in 130 countries – and with special services e.g. application consulting or motion control solutions.

***Energy efficiency***Energy management process

Efficient energy management consultancy identifies the energy flows, determines the potential for making savings and implements them with focused activities.

Almost two thirds of the industrial power requirement is from electric motors. This makes it all the more important to use drive technology permitting energy consumption to be reduced effectively even in the configuration phase, and consequently to optimize plant availability and process stability. With SINAMICS, Siemens offers powerful energy efficient solutions which, depending on the application, enable a significant reduction in electricity costs.

## System overview

### The SINAMICS drive family

#### Overview (continued)

##### Up to 70 % potential for savings using variable speed operation

SINAMICS enables great potential for savings to be realized by controlling the motor speed. In particular, huge potential savings can be recovered from pumps, fans and compressors which are operated with mechanical throttle and valves. Here, changing to variable-speed drives brings enormous economic advantages. In contrast to mechanical control systems, the power consumption at partial load operation is always immediately adjusted to the demand at that time. So energy is no longer wasted, permitting savings of up to 60 % – in exceptional cases even up to 70 %. Variable-speed drives also offer clear advantages over mechanical control systems when it comes to maintenance and repair. Current spikes when starting up the motor and strong torque surges become things of the past – and the same goes for pressure waves in pipelines, cavitation or vibrations which cause sustainable damage to the plant. Smooth starting and ramp-down relieve the load on the mechanical system, ensuring a significantly longer service life of the entire drive train.

##### Regenerative feedback of braking energy

In conventional drive systems, the energy produced during braking is converted to heat using braking resistors. Energy produced during braking is efficiently recovered to the supply system by versions of SINAMICS G and SINAMICS S drives with regenerative feedback capability and these devices do not therefore need a braking resistor. This permits up to 60 % of the energy requirement to be saved, e.g. in lifting applications. Energy which can be reused at other locations on a machine. Furthermore, this reduced power loss simplifies the cooling of the system, enabling a more compact design.

##### Energy transparency in all configuration phases

Early on, in the configuration phase, the SIZER for Siemens Drives engineering tool provides information on the specific energy requirement. The energy consumption across the entire drive train is visualized and compared with different plant concepts.

##### SINAMICS in combination with energy-saving motors

Engineering integration stretches beyond the SINAMICS drive family to higher-level automation systems, and to a broad spectrum of energy-efficient motors with a wide range of performance classes, which, compared to previous motors, are able to demonstrate up to 10 % greater efficiency.

#### Variants

Depending on the application, the SINAMICS range offers the ideal variant for any drive task.

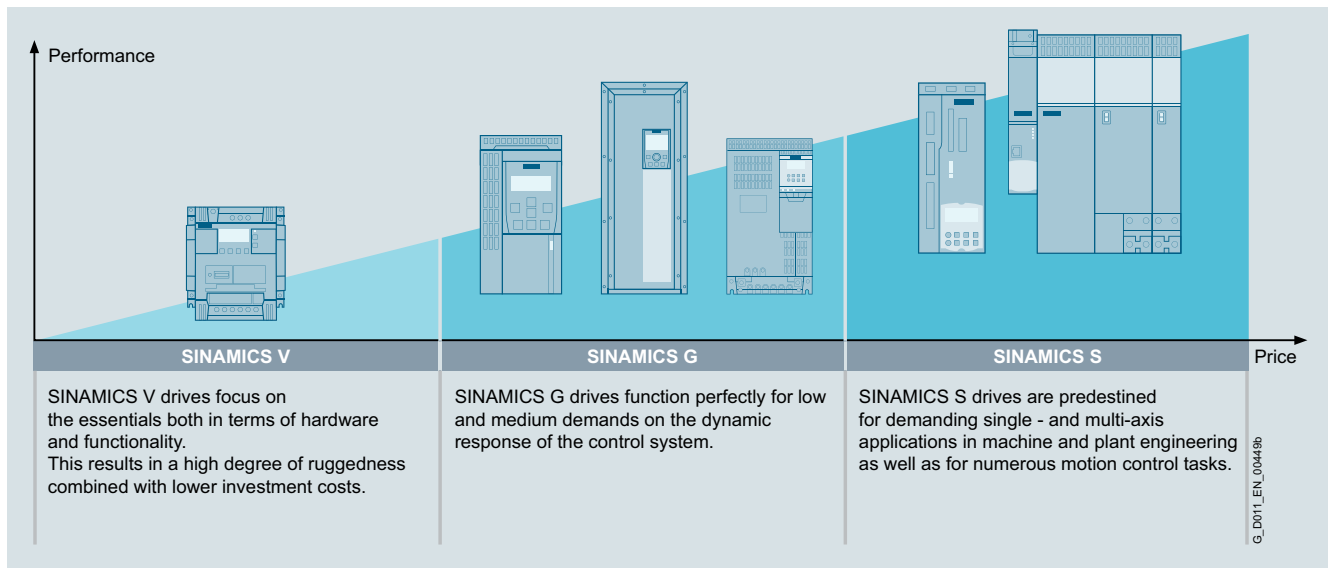

Overview (continued)

Platform concept

All SINAMICS variants are based on a platform concept. Joint hardware and software components, as well as standardized tools for dimensioning, configuration, and commissioning tasks ensure high-level integration across all components. SINAMICS handles a wide variety of drive tasks with no system gaps. The different SINAMICS variants can be easily combined with each other.

Quality management according to EN ISO 9001

SINAMICS conforms to the most exacting quality requirements. Comprehensive quality assurance measures in all development and production processes ensure a consistently high level of quality.

Of course, our quality management system is certified by an independent authority in accordance with EN ISO 9001.

IDS – Integration at its very best

The Siemens Integrated Drive Systems (IDS) solution offers perfectly matched drive components with which you can meet your requirements. The drive components reveal their true strengths as an Integrated Drive System over the full range from engineering and commissioning through to operation: Integrated system configuration is performed using the Drive Technology Configurator: Just select a motor and a converter and design them with the SIZER for Siemens Drives engineering tool. The STARTER and SINAMICS Startdrive commissioning tools integrate the motor data and at the same time simplify efficient commissioning. Integrated Drive Systems are incorporated in the TIA Portal – this simplifies engineering, commissioning and diagnostics.

Low voltage										Direct voltage	Medium voltage
Standard performance frequency converters		Distributed frequency converters	Industry-specific frequency converters		Servo drives			High performance frequency converters		DC converters	Converters for applications with high outputs
SINAMICS V20 G120C G120	SINAMICS G130 G150	SINAMICS G110D G120D G110M SIMATIC ET 200pro FC-2	SINAMICS G120X	SINAMICS G180	SINAMICS V90	SINAMICS S110	SINAMICS S210	SINAMICS S120 S120M	SINAMICS S150	SINAMICS DCM DCP *	SINAMICS GH150 GH180 GM150 SM150 GL150 SL150 SM120CM
0.12 kW to 250 kW	75 kW to 2700 kW	0.37 kW to 7.5 kW	0.75 kW to 630 kW	2.2 kW to 6600 kW	0.05 kW to 7 kW	0.55 kW to 132 kW	0.05 kW to 7 kW	0.55 kW to 5700 kW	75 kW to 1200 kW	6 kW to 30 MW	0.15 MW to 85 MW
Pumps, fans, compressors, conveyor belts, mixers, mills, spinning machines, textile machines, refrigerated display counters, fitness equipment, ventilation systems, single-axis positioning applications in machine and plant engineering	Pumps, fans, compressors, conveyor belts, mixers, mills, extruders	Conveyor technology, single-axis positioning applications (G120D)	Pumps, fans, compressors, building management systems, process industry, HVAC, water/waste water industries	Pumps, fans, compressors, conveyor belts, extruders, mixers, mills, kneaders, centrifuges, separators	Handling machines, packaging machines, automatic assembly machines, metal forming machines, printing machines, winding and unwinding units	Single-axis positioning applications in machine and plant engineering	Packaging machines, handling equipment, feed and withdrawal devices, stacking units, automatic assembly machines, laboratory automation, wood, glass and ceramics industry, digital printing machines	Production machines (packaging, textile and printing machines, paper machines, plastic processing machines), machine tools, plants, process lines and rolling mills, marine drives, test bays	Test bays, cross cutters, centrifuges	Rolling mill drives, wire-drawing machines, extruders and kneaders, cableways and lifts, test bay drives	Pumps, fans, compressors, mixers, extruders, mills, crushers, rolling mills, conveyor technology, excavators, test bays, blast furnace fans, retrofit
Catalog D 31.1	Catalog D 11	Catalog D 31.2	Catalog D 31.5	Catalog D 18.1	Catalog D 33	Catalog D 31.1	Catalog D 32	Catalogs D 21.3, D 21.4 NC 62	Catalog D 21.3	Catalog D 23.1 * Industry Mall	Catalogs D 15.1, D 12
Engineering tools (e.g. Drive Technology Configurator, SIZER for Siemens Drives, STARTER and SINAMICS Startdrive)											

G\_D011\_EN\_004500





# System overview

## Drive selection

1

### Overview

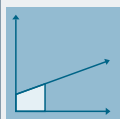
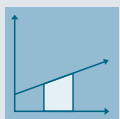
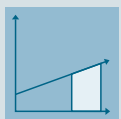
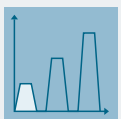
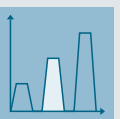
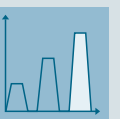
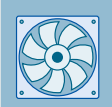
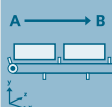
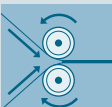
#### SINAMICS selection guide – typical applications

Use	Requirements for torque accuracy/speed accuracy/position accuracy/coordination of axes/functionality					
	Continuous motion			Non-continuous motion		
	Basic	Medium	High	Basic	Medium	High
						
<b>Pumping, ventilating, compressing</b> 	Centrifugal pumps Radial / axial fans Compressors  V20 G120C G120X	Centrifugal pumps Radial / axial fans Compressors  G120X G130/G150 G180 <sup>1)</sup>	Eccentric screw pumps  S120	Hydraulic pumps Metering pumps  G120	Hydraulic pumps Metering pumps  S110	Descaling pumps Hydraulic pumps  S120
<b>Moving</b> 	Conveyor belts Roller conveyors Chain conveyors  V20 G110D G110M G120C ET 200pro FC-2 <sup>2)</sup>	Conveyor belts Roller conveyors Chain conveyors Lifting/lowering devices Elevators Escalators/moving walkways Indoor cranes Marine drives Cable railways  G120 G120D G130/G150 G180 <sup>1)</sup>	Elevators Container cranes Mining hoists Excavators for open-cast mining Test bays  S120 S150 DCM	<b>Acceleration conveyors</b> <b>Storage and retrieval machines</b>  <b>V90</b> G120 G120D	Acceleration conveyors Storage and retrieval machines Cross cutters Reel changers  S110 S210 DCM	Storage and retrieval machines Robotics Pick & place Rotary indexing tables Cross cutters Roll feeds Engagers/disengagers  S120 S210 DCM
<b>Processing</b> 	Mills Mixers Kneaders Crushers Agitators Centrifuges  V20 G120C	Mills Mixers Kneaders Crushers Agitators Centrifuges Extruders Rotary furnaces  G120 G130/G150 G180 <sup>1)</sup>	Extruders Winders/unwinders Lead/follower drives Calenders Main press drives Printing machines  S120 S150 DCM	<b>Tubular bagging machines</b> <b>Single-axis motion control</b> such as • Position profiles • Path profiles  <b>V90</b> G120	Tubular bagging machines Single-axis motion control such as • Position profiles • Path profiles  S110 S210	Servo presses Rolling mill drives Multi-axis motion control such as • Multi-axis positioning • Cams • Interpolations  S120 S210 DCM
<b>Machining</b> 	Main drives for • Turning • Milling • Drilling  S110	Main drives for • Drilling • Sawing  S110 S120	Main drives for • Turning • Milling • Drilling • Gear cutting • Grinding  S120	Axis drives for • Turning • Milling • Drilling  S110	Axis drives for • Drilling • Sawing  S110 S120	Axis drives for • Turning • Milling • Drilling • Lasering • Gear cutting • Grinding • Nibbling and punching  S120

#### Using the SINAMICS selection guide

The varying range of demands on modern variable frequency drives requires a large number of different types. Selecting the optimum drive has become a significantly more complex process. The application matrix shown simplifies this selection process considerably, by suggesting the ideal SINAMICS drive for examples of typical applications and requirements.

- The application type is selected from the vertical column
  - Pumping, ventilating, compressing
  - Moving
  - Processing
  - Machining
- The quality of the motion type is selected from the horizontal row
  - Basic
  - Medium
  - High

#### More information

Further information about SINAMICS is available on the Internet at [www.siemens.com/sinamics](http://www.siemens.com/sinamics)

Practical application examples and descriptions are available on the Internet at [www.siemens.com/sinamics-applications](http://www.siemens.com/sinamics-applications)

<sup>1)</sup> Industry-specific converters.

<sup>2)</sup> Information on the SIMATIC ET 200pro FC-2 frequency converter is available in Catalog D 31.2 and at [www.siemens.com/et200pro-fc](http://www.siemens.com/et200pro-fc)

## Overview

### SINAMICS V90 servo drive system



The performance-optimized, user-friendly servo drive system comprises a SINAMICS V90 servo drive and a SIMOTICS S-1FL6 servomotor. There are eight different servo drive frame sizes and seven motor shaft heights for operation on single and three-phase line supplies with power ratings ranging from 0.05 to 7.0 kW, to realize a wide range of applications, with the focus on dynamic motion and processing - for example positioning, transporting and winding.

In addition to operation in the TIA Portal V14 with the new SIMATIC 1500 T-CPU Advanced Controller, the servo drive system is also suitable for use with the SIMATIC S7-1500 Advanced Controller and the SIMATIC S7-1200 Basic Controller.

## Benefits

### Cost-effective - many integrated functions to reduce machine costs

#### Integrated control modes

Pulse train input position control mode (PTI), internal position control mode (IPos) with traversing block or Modbus, speed control mode and torque control are all integrated in the SINAMICS V90.

**The drive has various integrated control modes to address a wide range of applications.**

#### Integrated PROFINET – the industrial Ethernet standard for automation

SINAMICS V90 PROFINET version features PROFINET, enabling real-time transmission of user/process data and diagnostic data with a single cable.

**This solution offers wide-ranging functions with reduced complexity.**

#### Integrated positioning function

- Positioning function is integrated in the drive. Target positions and respective speeds can be stored in the drive during commissioning or changed via communication.
- Absolute or relative positioning
- Rotary or linear axes
- Referencing in the drive

**Point-to-point positioning possible using a PLC without positioning functionality.**

#### Integrated braking resistor for all frame sizes and max. motor power $\geq 0.2$ kW

All frame sizes with max. motor power  $\geq 0.2$  kW have an integrated braking resistor to dissipate the regenerative power for fast braking.

**Most applications can be realized without an additional braking resistor.**

#### Integrated holding brake switch (SINAMICS V90, 400 V version)

Integrated holding brake switch - the brake can be directly connected to the drive if a motor with holding brake is used.

**Holding brake can be connected without requiring an external relay (only for SINAMICS V90, 400 V version).**

### Easy to use - Simple tuning and quick commissioning

#### Easy servo tuning and machine optimization

The system can be automatically optimized using the auto tuning function and automatic suppression of machine resonances.

**Simply plug & play, no in-depth servo know-how required.**

#### Easy commissioning using the SINAMICS V-ASSISTANT engineering tool

Graphic user interface guides the user when setting application-specific parameters; intuitive drive and motor status check; integrated trace and measuring functionality.

**SINAMICS V-ASSISTANT makes commissioning and diagnostics quick and easy.**

[www.siemens.com/sinamics-v-assistant](http://www.siemens.com/sinamics-v-assistant)

#### Simple connection to a control system

- Two-channel pulse train for position setpoint, one exclusively for 5 V differential (RS422 standard), one for 24 V single ended signal (for pulse train version)
- Standard RS485 interface supports USS and Modbus RTU (pulse train version)
- Industrial Ethernet standard PROFINET with PROFIdrive (PROFINET version)

**Standard interface makes it easy to connect the drive with PLCs and motion controller.**

#### Easy, all from a single source

- Predefined drive/motor bundles and accessories, easy to select
- Tested with SIMATIC PLC/HMI and ready-to-run application examples for connecting a SINAMICS V90 drive to a controller
- Different application examples can be downloaded free of charge from the Online Support Portal

#### Parameter cloning

SINAMICS V90 servo drives are equipped with a standard SD card slot (400 V version) and a Micro SD card slot (200 V version), so that parameter settings can be easily transferred between drive devices.

**Efficient commissioning of machine series.**

# System overview

## SINAMICS V90 basic servo drive system

### Application

#### Application examples

##### SINAMICS V90 servo drive system

###### 200 V ... 240 V 1 AC/3 AC

Low Inertia  
for high dynamic performance

Electronic assembly industry,  
for example

- Pick and place machine
- Stencil cutting machine
- PCB assembly machine
- IC handling machine
- Chip sorting machine
- Bonding machine

Converting/printing industry,  
for example

- Labeling machine
- Slitter machine
- Laminating/coating machine
- Screen printing machine

Packaging industry,  
for example

- Filling and sealing machine
- Blister machine  
(pharmaceutical packaging)
- Bag packing machine

Material handling machinery,  
for example

- Automatic palletizers

###### 380 V ... 480 V 3 AC

High Inertia  
for smooth operational performance

Metal forming machinery,  
for example

- Punching machine
- Engraving machine
- Edging press

Converting/printing industry,  
for example

- Winders
- Slitter machine
- Laminating/coating machine
- Screen printing machine
- Wire drawing machine

Packaging industry,  
for example

- Filling machine
- Blister machine  
(pharmaceutical packaging)
- Bag packing machine

Material handling machinery,  
for example

- Storage and warehouse systems
- Conveyor systems

### Design

#### System topology

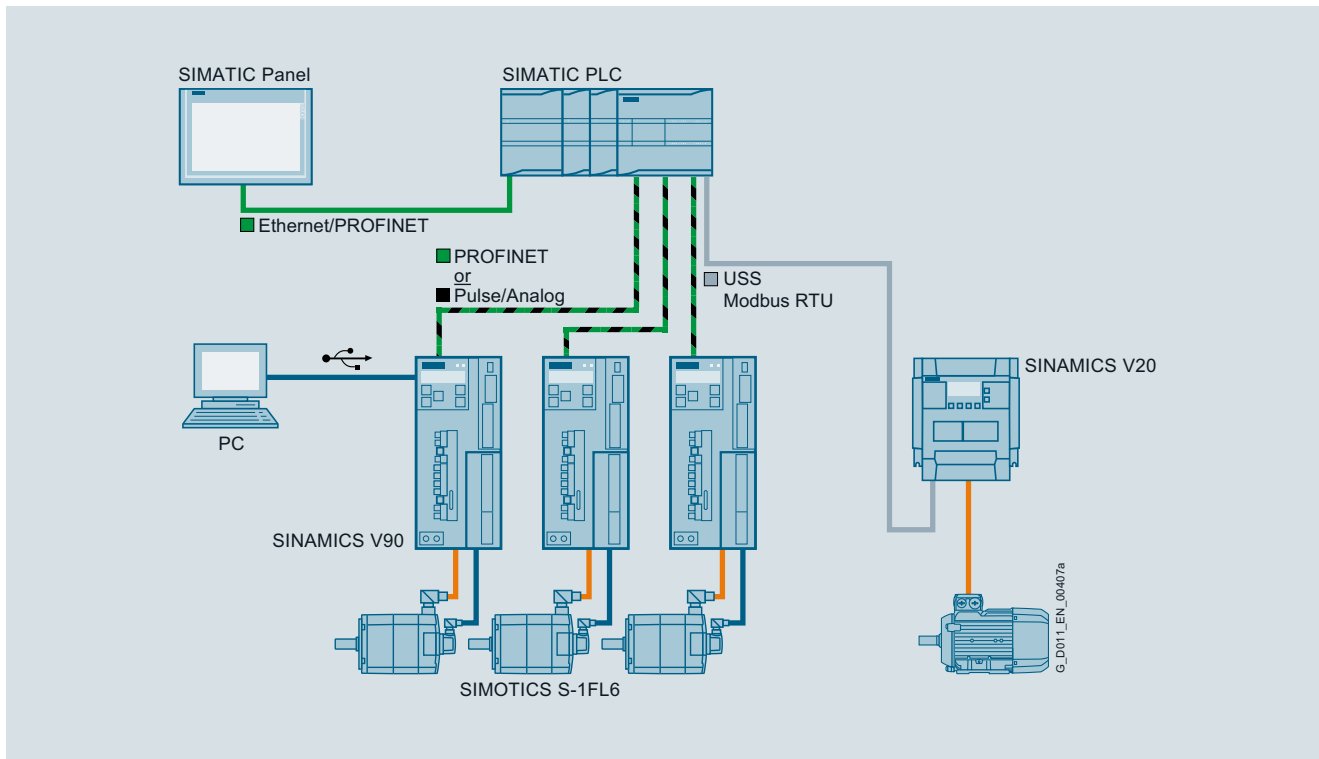

## System overview

Clicking to the Industry Mall

6SL3255-0AA00-5AA0



## SINAMICS V90 basic servo drive system

## Selection and ordering data

## SIMOTICS S-1FL6 servomotors → Configuration with SINAMICS V90 servo drive

Further info in section SIMOTICS S-1FL6 servomotors.

Max. speed	Rated power <sup>1)</sup>	Static torque	Rated torque <sup>1)</sup>	Max. torque <sup>1)</sup>	Rated current	Max. current	Article No.	Torque constant	Moment of inertia of rotor		Recommended load to motor inertia ratio, max.	Weight <sup>2)</sup>	
$n_{max}$	$P_{rated}$ at $\Delta T=100$ K	$M_0$ at $\Delta T=100$ K	$M_{rated}$ at $\Delta T=100$ K	$M_{max}$	$I_{rated}$ at $\Delta T=100$ K	$I_{max}$		Nm/A	$J_{without\ brake}$	$J_{with\ brake}$		$m_{without\ brake}$	$m_{with\ brake}$
rpm	kW (hp)	Nm	Nm	Nm	A	A			$10^{-4}$ kgm <sup>2</sup>			kg	kg
<b>SIMOTICS S-1FL6 Low Inertia servomotors – High dynamic performance</b>													
<b>Shaft height 20 – Rated speed <math>n_{rated}</math> 3000 rpm</b>													
5000	0.05 (0.07)	0.16	0.16	0.48	1.2	3.6	1FL6022-2AF21-1 ■ ■ ■ 1	0.14	0.031	0.038	30×	0.47	0.7
5000	0.10 (0.14)	0.32	0.32	0.96	1.2	3.6	1FL6024-2AF21-1 ■ ■ ■ 1	0.29	0.052	0.059	30×	0.63	0.86
<b>Shaft height 30 – Rated speed <math>n_{rated}</math> 3000 rpm</b>													
5000	0.20 (0.27)	0.64	0.64	1.91	1.4	4.2	1FL6032-2AF21-1 ■ ■ ■ 1	0.48	0.214	0.245	30×	1.02	1.48
5000	0.40 (0.54)	1.27	1.27	3.82	2.6	7.8	1FL6034-2AF21-1 ■ ■ ■ 1	0.49	0.351	0.381	30×	1.46	1.92
<b>Shaft height 40 – Rated speed <math>n_{rated}</math> 3000 rpm</b>													
5000	0.75 (1.02)	2.39	2.39	7.2	4.7	14.2	1FL6042-2AF21-1 ■ ■ ■ 1	0.51	0.897	1.06	20×	2.8	3.68
<b>Shaft height 40 – Rated speed <math>n_{rated}</math> 3000 rpm</b>													
5000	1.00 (1.36)	3.18	3.18	9.54	6.3	18.9	1FL6044-2AF21-1 ■ ■ ■ 1	0.51	1.15	1.31	20×	3.39	4.2
<b>Shaft height 50 – Rated speed <math>n_{rated}</math> 3000 rpm</b>													
5000	1.50 (2.04)	4.78	4.78	14.3	10.6	31.8	1FL6052-2AF21-2 ■ ■ ■ 1	0.46	2.04	2.24	15×	5.45	6.96
5000	2.00 (2.72)	6.37	6.37	19.1	11.6	34.8	1FL6054-2AF21-2 ■ ■ ■ 1	0.55	2.62	2.82		6.66	8.2
<b>SIMOTICS S-1FL6 High Inertia servomotors – Smooth operational performance</b>													
<b>Shaft height 45 – Rated speed <math>n_{rated}</math> 3000 rpm</b>													
4000	0.4 (0.54)	1.9	1.27	3.8	1.2	3.6	1FL6042-1AF61-2 ■ ■ ■ 1	1.1	2.7	3.2	10×	3.4	4.8
4000	0.75 (1.02)	3.5	2.39	7.2	2.1	6.3	1FL6044-1AF61-2 ■ ■ ■ 1	1.2	5.2	5.7		5.2	6.6
<b>Shaft height 65 – Rated speed <math>n_{rated}</math> 2000 rpm</b>													
3000	0.75 (1.02)	4	3.58	10.7	2.5	7.5	1FL6061-1AC61-2 ■ ■ ■ 1	1.5	8	9.1	5×	5.7	8.8
3000	1 (1.36)	6	4.78	14.3	3	9	1FL6062-1AC61-2 ■ ■ ■ 1	1.7	11.7	13.5		7	10.1
3000	1.5 (2.04)	8	7.16	21.5	4.6	13.8	1FL6064-1AC61-2 ■ ■ ■ 1	1.6	15.3	16.4		8.4	11.5
3000	1.75 (2.38)	11	8.36	25.1	5.3	15.9	1FL6066-1AC61-2 ■ ■ ■ 1	1.7	22.6	23.7		11.1	14.2
3000	2 (2.72)	15	9.55	28.7	5.9	17.7	1FL6067-1AC61-2 ■ ■ ■ 1	1.7	29.9	31		13.7	16.8
<b>Shaft height 90 – Rated speed <math>n_{rated}</math> 2000 rpm</b>													
3000	2.5 (3.40)	15	11.9	35.7	7.8	23.4	1FL6090-1AC61-2 ■ ■ ■ 1	1.6	47.4	56.3	5×	15.4	21.5
3000	3.5 (4.76)	22	16.7	50	11	33	1FL6092-1AC61-2 ■ ■ ■ 1	1.6	69.1	77.9		19.8	25.9
2500	5 (6.80)	30	23.9	70	12.6	36.9	1FL6094-1AC61-2 ■ ■ ■ 1	2.0	90.8	99.7		24.4	30.5
2000	7 (9.52)	40	33.4	90	13.2	35.6	1FL6096-1AC61-2 ■ ■ ■ 1	2.7	134.3	143.2		33.3	39.3

## Encoder type

Incremental encoder TTL, 2500 S/R

Absolute encoder 20-bit single-turn + 12-bit multi-turn

1FL6 Low Inertia: Absolute encoder 21-bit single-turn

A

L

M

## Shaft extension Holding brake

Feather key Without

Feather key With

Plain shaft Without

Plain shaft With

A

B

G

H

Detailed information on SINAMICS V90 is available on the Internet at: [www.siemens.com/sinamics-v90](http://www.siemens.com/sinamics-v90)In addition, the Drive Technology Configurator (DT Configurator) can be used on the Internet: [www.siemens.com/dt-configurator](http://www.siemens.com/dt-configurator)

<sup>1)</sup> Rated torque, rated power and maximum torque listed in the table above allow for a production tolerance of 10 %.

<sup>2)</sup> Motor weight with incremental encoder.



6SL3255-0AA00-5AA0



## SINAMICS V90 basic servo drive system

1

SINAMICS V90 servo drive Further info in section SINAMICS V90 servo drive.		Line filter	Recommended standard fuse		Recommended circuit breaker
Max. motor power	Frame size	With one of the recommended line filters, EN 61008-3 category C2 can be reached in combination with SINAMICS V90. <a href="#">For more information please refer to SINAMICS V90 Operating instructions.</a>	corresponding to IEC standard	corresponding to UL standard	corresponding to IEC standard/ UL standard
kW (hp)	Article No.	Line supply voltage	$I_{rated}$	$I_{rated}$	$I_{rated}$ Class
		V	A	A	A
		Article No.	Article No.	Article No.	Article No.
<b>SINAMICS V90 servo drive</b>					
<b>Line supply 200 ... 240 V 1 AC/3 AC</b>					
0.10 (0.14)	<b>6SL3210-5FB10-1U ■ 2</b>	FSA	200 ... 240 1 AC 18	<b>6SL3203-0BB21-8VA0</b>	6 <b>3NA3801</b> 6 Listed JDDZ
			200 ... 240 3 AC 5	<b>6SL3203-0BE15-0VA0</b>	
			200 ... 240 1 AC 18	<b>6SL3203-0BB21-8VA0</b>	
			200 ... 240 3 AC 5	<b>6SL3203-0BE15-0VA0</b>	
<b>Line supply 200 ... 240 V 1 AC/3 AC</b>					
0.20 (0.27)	<b>6SL3210-5FB10-2U ■ 2</b>	FSA	200 ... 240 1 AC 18	<b>6SL3203-0BB21-8VA0</b>	6 <b>3NA3801</b> 6 Listed JDDZ
			200 ... 240 3 AC 5	<b>6SL3203-0BE15-0VA0</b>	
0.40 (0.54)	<b>6SL3210-5FB10-4U ■ 1</b>	FSB	200 ... 240 1 AC 18	<b>6SL3203-0BB21-8VA0</b>	10 <b>3NA3803</b> 10
			200 ... 240 3 AC 5	<b>6SL3203-0BE15-0VA0</b>	
<b>Line supply 200 ... 240 V 1 AC/3 AC</b>					
0.75 (1.02)	<b>6SL3210-5FB10-8U ■ 0</b>	FSC	200 ... 240 1 AC 18	<b>6SL3203-0BB21-8VA0</b>	16 <b>3NA3805</b> 20 Listed JDDZ
			200 ... 240 3 AC 5	<b>6SL3203-0BE15-0VA0</b>	
<b>Line supply 200 ... 240 V 3 AC</b>					
1.00 (1.36)	<b>6SL3210-5FB11-0U ■ 1</b>	FSD	200 ... 240 3 AC 12	<b>6SL3203-0BE21-2VA0</b>	16 <b>3NA3805</b> 20 Listed JDDZ
<b>Line supply 200 ... 240 V 3 AC</b>					
1.50 (2.04)	<b>6SL3210-5FB11-5U ■ 0</b>	FSD	200 ... 240 3 AC 12	<b>6SL3203-0BE21-2VA0</b>	25 <b>3NA3810</b> 25 Listed JDDZ
2.00 (2.72)	<b>6SL3210-5FB12-0U ■ 0</b>				
<b>SINAMICS V90 servo drive</b>					
<b>Line supply 380 ... 480 V 3 AC</b>					
0.4 (0.54)	<b>6SL3210-5FE10-4U ■ 0</b>	FSAA	380 ... 480 3 AC 5	<b>6SL3203-0BE15-0VA0</b>	6 <b>3NA3801-6</b> 10 Listed JDDZ
0.75 (1.02)	<b>6SL3210-5FE10-8U ■ 0</b>	FSA			
<b>Line supply 380 ... 480 V 3 AC</b>					
1 (1.36)	<b>6SL3210-5FE11-0U ■ 0</b>	FSA	380 ... 480 3 AC 5	<b>6SL3203-0BE15-0VA0</b>	10 <b>3NA3803-6</b> 10 Listed JDDZ
1.75 (2.38)	<b>6SL3210-5FE11-5U ■ 0</b>	FSB	12	<b>6SL3203-0BE21-2VA0</b>	15
2.5 (3.40)	<b>6SL3210-5FE12-0U ■ 0</b>				16 <b>3NA3805-6</b>
<b>Line supply 380 ... 480 V 3 AC</b>					
2.5 (3.40)	<b>6SL3210-5FE12-0U ■ 0</b>	FSB	380 ... 480 3 AC 12	<b>6SL3203-0BE21-2VA0</b>	16 <b>3NA3805-6</b> 15 Listed JDDZ
3.5 (4.76)	<b>6SL3210-5FE13-5U ■ 0</b>	FSC	20	<b>6SL3203-0BE22-0VA0</b>	20 <b>3NA3807-6</b> 25
5 (6.80)	<b>6SL3210-5FE15-0U ■ 0</b>				
7 (9.52)	<b>6SL3210-5FE17-0U ■ 0</b>				25 <b>3NA3810-6</b>
SINAMICS V90, pulse train (PTI) version	<b>A</b>				
SINAMICS V90, PROFINET (PN) version	<b>F</b>				

## System overview

Clicking to the Industry Mall

6SL3255-0AA00-5AA0



## SINAMICS V90 basic servo drive system

## Selection and ordering data (continued)

**SIMOTICS S-1FL6 servomotors – Configuration with MOTION-CONNECT connection systems**  
 Further info in section SIMOTICS S-1FL6 servomotors.

Max. speed	Rated power <sup>1)</sup>	Static torque	Rated torque <sup>1)</sup>	Max. torque <sup>1)</sup>	Rated current	Max. current	Article No.	Torque constant	Moment of inertia of rotor		Recommended load to motor inertia ratio, max.	Weight <sup>2)</sup>		
$n_{max}$	$P_{rated}$ at $\Delta T=100$ K	$M_0$ at $\Delta T=100$ K	$M_{rated}$ at $\Delta T=100$ K	$M_{max}$	$I_{rated}$ at $\Delta T=100$ K	$I_{max}$		Nm/A	$J_{without\ brake}$	$J_{with\ brake}$		$m_{without\ brake}$	$m_{with\ brake}$	
rpm	kW (hp)	Nm	Nm	Nm	A	A			$10^{-4}$ kgm <sup>2</sup>	$10^{-4}$ kgm <sup>2</sup>		kg	kg	
<b>SIMOTICS S-1FL6 Low Inertia servomotors – High dynamic performance</b>														
<b>Shaft height 20 – Rated speed <math>n_{rated}</math> 3000 rpm</b>														
5000	0.05 (0.07)	0.16	0.16	0.48	1.2	3.6	1FL6022-2AF21-1 ■ ■ ■ 1	0.14	0.031	0.038	30x	0.47	0.7	
5000	0.10 (0.14)	0.32	0.32	0.96	1.2	3.6	1FL6024-2AF21-1 ■ ■ ■ 1	0.29	0.052	0.059	30x	0.63	0.86	
<b>Shaft height 30 – Rated speed <math>n_{rated}</math> 3000 rpm</b>														
5000	0.20 (0.27)	0.64	0.64	1.91	1.4	4.2	1FL6032-2AF21-1 ■ ■ ■ 1	0.48	0.214	0.245	30x	1.02	1.48	
5000	0.40 (0.54)	1.27	1.27	3.82	2.6	7.8	1FL6034-2AF21-1 ■ ■ ■ 1	0.49	0.351	0.381	30x	1.46	1.92	
<b>Shaft height 40 – Rated speed <math>n_{rated}</math> 3000 rpm</b>														
5000	0.75 (1.02)	2.39	2.39	7.2	4.7	14.2	1FL6042-2AF21-1 ■ ■ ■ 1	0.51	0.897	1.06	20x	2.8	3.68	
<b>Shaft height 40 – Rated speed <math>n_{rated}</math> 3000 rpm</b>														
5000	1.00 (1.36)	3.18	3.18	9.54	6.3	18.9	1FL6044-2AF21-1 ■ ■ ■ 1	0.51	1.15	1.31	20x	3.39	4.2	
<b>Shaft height 50 – Rated speed <math>n_{rated}</math> 3000 rpm</b>														
5000	1.50 (2.04)	4.78	4.78	14.3	10.6	31.8	1FL6052-2AF21-2 ■ ■ ■ 1	0.46	2.04	2.24	15x	5.45	6.96	
5000	2.00 (2.72)	6.37	6.37	19.1	11.6	34.8	1FL6054-2AF21-2 ■ ■ ■ 1	0.55	2.62	2.82		6.66	8.2	
<b>SIMOTICS S-1FL6 High Inertia servomotors – Smooth operational performance</b>														
<b>Shaft height 45 – Rated speed <math>n_{rated}</math> 3000 rpm</b>														
4000	0.4 (0.54)	1.9	1.27	3.8	1.2	3.6	1FL6042-1AF61-2 ■ ■ ■ 1	1.1	2.7	3.2	10x	3.4	4.8	
4000	0.75 (1.02)	3.5	2.39	7.2	2.1	6.3	1FL6044-1AF61-2 ■ ■ ■ 1	1.2	5.2	5.7		5.2	6.6	
<b>Shaft height 65 – Rated speed <math>n_{rated}</math> 2000 rpm</b>														
3000	0.75 (1.02)	4	3.58	10.7	2.5	7.5	1FL6061-1AC61-2 ■ ■ ■ 1	1.5	8	9.1	5x	5.7	8.8	
3000	1 (1.36)	6	4.78	14.3	3	9	1FL6062-1AC61-2 ■ ■ ■ 1	1.7	11.7	13.5		7	10.1	
3000	1.5 (2.04)	8	7.16	21.5	4.6	13.8	1FL6064-1AC61-2 ■ ■ ■ 1	1.6	15.3	16.4		8.4	11.5	
3000	1.75 (2.38)	11	8.36	25.1	5.3	15.9	1FL6066-1AC61-2 ■ ■ ■ 1	1.7	22.6	23.7		11.1	14.2	
3000	2 (2.72)	15	9.55	28.7	5.9	17.7	1FL6067-1AC61-2 ■ ■ ■ 1	1.7	29.9	31		13.7	16.8	
<b>Shaft height 90 – Rated speed <math>n_{rated}</math> 2000 rpm</b>														
3000	2.5 (3.40)	15	11.9	35.7	7.8	23.4	1FL6090-1AC61-2 ■ ■ ■ 1	1.6	47.4	56.3	5x	15.4	21.5	
3000	3.5 (4.76)	22	16.7	50	11	33	1FL6092-1AC61-2 ■ ■ ■ 1	1.6	69.1	77.9		19.8	25.9	
2500	5 (6.80)	30	23.9	70	12.6	36.9	1FL6094-1AC61-2 ■ ■ ■ 1	2.0	90.8	99.7		24.4	30.5	
2000	7 (9.52)	40	33.4	90	13.2	35.6	1FL6096-1AC61-2 ■ ■ ■ 1	2.7	134.3	143.2		33.3	39.3	

## Encoder type

Incremental encoder TTL, 2500 S/R

Absolute encoder 20-bit single-turn + 12-bit multi-turn

1FL6 Low Inertia: Absolute encoder 21-bit single-turn

A

L

M

## Shaft extension Holding brake

Feather key Without

Feather key With

Plain shaft Without

Plain shaft With

A

B

G

H

Detailed information on SINAMICS V90 is available on the Internet at: [www.siemens.com/sinamics-v90](http://www.siemens.com/sinamics-v90)In addition, the Drive Technology Configurator (DT Configurator) can be used on the Internet: [www.siemens.com/dt-configurator](http://www.siemens.com/dt-configurator)

<sup>1)</sup> Rated torque, rated power and maximum torque listed in the table above allow for a production tolerance of 10 %.

<sup>2)</sup> Motor weight with incremental encoder.

6SL3255-0AA00-5AA0



SINAMICS V90 basic servo drive system

1

**MOTION-CONNECT connection systems** Further info in section MOTION-CONNECT connection systems.

Pre-assembled power cables		Pre-assembled signal cables				Connectors			
No. of cores x conductor cross-section		SINAMICS V90 – Incremental encoder on the 1FL6 servo- motor	SINAMICS V90 – Absolute encoder on the 1FL6 servomotor	SINAMICS V90 – Brake on the 1FL6 servomotor with holding brake	Motor side for power connection	Motor side for incre- mental encoder	for absolute encoder	for brake	
mm <sup>2</sup>	Article No.	Article No.	Article No.	Article No.	Article No.	Article No.	Article No.	Article No.	

**MOTION-CONNECT connection systems**

4 x 0.75	6FX3002-5CK01-1 ■ ■ 0	6FX3002-2CT20-1 ■ ■ 0	6FX3002-2DB20-1 ■ ■ 0	6FX3002-5BK02-1 ■ ■ 0	6FX2003-0LL12	6FX2003-0SL12	6FX2003-0DB12	6FX2003-0LL52
4 x 0.75	6FX3002-5CK01-1 ■ ■ 0	6FX3002-2CT20-1 ■ ■ 0	6FX3002-2DB20-1 ■ ■ 0	6FX3002-5BK02-1 ■ ■ 0	6FX2003-0LL12	6FX2003-0SL12	6FX2003-0DB12	6FX2003-0LL52
4 x 0.75	6FX3002-5CK01-1 ■ ■ 0	6FX3002-2CT20-1 ■ ■ 0	6FX3002-2DB20-1 ■ ■ 0	6FX3002-5BK02-1 ■ ■ 0	6FX2003-0LL12	6FX2003-0SL12	6FX2003-0DB12	6FX2003-0LL52
4 x 0.75	6FX3002-5CK01-1 ■ ■ 0	6FX3002-2CT20-1 ■ ■ 0	6FX3002-2DB20-1 ■ ■ 0	6FX3002-5BK02-1 ■ ■ 0	6FX2003-0LL12	6FX2003-0SL12	6FX2003-0DB12	6FX2003-0LL52
4 x 2.5	6FX3002-5CK32-1 ■ ■ 0	6FX3002-2CT12-1 ■ ■ 0	6FX3002-2DB12-1 ■ ■ 0	6FX3002-5BL03-1 ■ ■ 0	6FX2003-0LL13	6FX2003-0SL13	6FX2003-0DB13	6FX2003-0LL53

**MOTION-CONNECT connection systems**

4 x 1.5	6FX3002-5CL02-1 ■ ■ 0	6FX3002-2CT12-1 ■ ■ 0	6FX3002-2DB10-1 ■ ■ 0	6FX3002-5BL03-1 ■ ■ 0	6FX2003-0LL13	6FX2003-0SL13	6FX2003-0DB11	6FX2003-0LL53
4 x 1.5	6FX3002-5CL02-1 ■ ■ 0	6FX3002-2CT12-1 ■ ■ 0	6FX3002-2DB10-1 ■ ■ 0	6FX3002-5BL03-1 ■ ■ 0	6FX2003-0LL13	6FX2003-0SL13	6FX2003-0DB11	6FX2003-0LL53
4 x 2.5	6FX3002-5CL12-1 ■ ■ 0							
4 x 2.5	6FX3002-5CL12-1 ■ ■ 0	6FX3002-2CT12-1 ■ ■ 0	6FX3002-2DB10-1 ■ ■ 0	6FX3002-5BL03-1 ■ ■ 0	6FX2003-0LL13	6FX2003-0SL13	6FX2003-0DB11	6FX2003-0LL53

Length	A	D	Length	A	D	Length	A	D	Length	A	D
3 m	A	D	3 m	A	D	3 m	A	D	3 m	A	D
5 m	A	F	5 m	A	F	5 m	A	F	5 m	A	F
7 m <sup>1)</sup>	A	H	7 m <sup>1)</sup>	A	H	7 m <sup>1)</sup>	A	H	7 m <sup>1)</sup>	A	H
10 m	B	A	10 m	B	A	10 m	B	A	10 m	B	A
15 m <sup>1)</sup>	B	F	15 m <sup>1)</sup>	B	F	15 m <sup>1)</sup>	B	F	15 m <sup>1)</sup>	B	F
20 m	C	A	20 m	C	A	20 m	C	A	20 m	C	A

Drive side	
for incre- mental encoder	for absolute encoder
Article No.	Article No.
6FX2003-0SB14	6FX2003-0SB14

<sup>1)</sup> Only available for High Inertia motors (400 V 3 AC).



## SINAMICS V90 basic servo drive system

1

## Accessories

## Connecting cables and connectors for SIMATIC S7 controller

For SINAMICS V90 pulse train (PTI) version		For SINAMICS V90 PROFINET (PN) version	
Description	Article No.	Description	Article No.
Setpoint cable with connector (MDR 50-pin connector, free pins to controller side), length: 1 m	<b>6SL3260-4NA00-1VB0</b>	I/O cable with 20-pin MDR connector (free pins to controller side), length: 1 m	<b>6SL3260-4MA00-1VB0</b>
Setpoint cable with connectors on both sides and separate terminal block (MDR 50-pin connector, terminal block to controller side), length: 0.5 m	<b>6SL3260-4NA00-1VA5</b>	Connector for I/O cable, 20-pin	<b>6SL3260-2MA00-0VA0</b>
50-pin MDR connector for setpoint cable	<b>6SL3260-2NA00-0VA0</b>	Pre-assembled PROFINET cable with two RJ45 180° plugs, length: 1 m	<b>6XV1871-5BH10</b>
		RJ45 data plug-in connector with 180° (straight) cable outlet	<b>6GK1901-1BB10-2AA0</b>
		Standard PROFINET cable, 4-core, sold by the meter, not assembled	<b>6XV1840-2AH10</b>

For further information about PROFINET cables refer to Catalog IK PI or on the Internet at:

[www.siemens.com/simatic-net](http://www.siemens.com/simatic-net)

## Requirements for external braking resistor

When the internal braking resistor is not sufficient, select a standard braking resistor according to the table.

Frame size	Resistance $\Omega$	Max. power kW	Rated power W	Max. energy kJ
<b>Line voltage 200 ... 240 V 1 AC/3 AC</b>				
FSA, 0.2 kW	150	1.09	20	0.8
FSB	100	1.64	21	1.23
FSC	50	3.28	62	2.46
FSD, 1 kW	50	3.28	62	2.46
FSD, 1.5 ... 2 kW	25	6.56	123	4.92
<b>Line voltage 380 ... 480 V 3 AC</b>				
FSA	533	1.2	30	2.4
FSA	160	4	100	8.0
FSB	70	9.1	229	18.3
FSC	27	23.7	1185	189.6

## Supplementary system components

Description	Article No.
SINAMICS SD card, 512 MB for SINAMICS V90 400 V version	<b>6SL3054-4AG00-2AA0</b>
Replacement connector kit for SINAMICS V90 400 V version FSA	<b>6SL3200-0WT00-0AA0</b>
Replacement connector kit for SINAMICS V90 400 V version FSA	<b>6SL3200-0WT01-0AA0</b>
Replacement connector kit for SINAMICS V90 200 V version FSA and FSB	<b>6SL3200-0WT02-0AA0</b>
Replacement connector kit for SINAMICS V90 200 V version FSC and FSD	<b>6SL3200-0WT03-0AA0</b>
Replacement fan for SINAMICS V90 200 V version FSD and 400 V version FSB	<b>6SL3200-0WF00-0AA0</b>
Replacement fan for SINAMICS V90 400 V version FSC	<b>6SL3200-0WF01-0AA0</b>

## SINAMICS V90 Starter Kit

Description	Article No.
Starter Kit – SINAMICS V90 with SIMOTICS S-1FL6 Low Inertia	<b>6SL3200-0AE40-0AA0</b>

## SINAMICS V90 training case

Description	Article No.
SINAMICS V90 training case 1-axis pulse train (PTI) version consisting of 1 × servo drive SINAMICS V90 pulse train (PTI) version, 1 × servomotor SIMOTICS S-1FL6 Low Inertia and 1 × controller SIMATIC S7-12000	<b>6AG1067-2AA00-0AC0</b>
SINAMICS V90 training case 1-axis pulse train (PTI) version consisting of 1 × servo drive SINAMICS V90 pulse train (PTI) version and 1 × servomotor SIMOTICS S-1FL6 High Inertia	<b>6AG1067-3AA00-0AB0</b>
SINAMICS V90 training case 2-axis PROFINET (PN) version consisting of 2 × servo drive SINAMICS V90 PROFINET (PN) version and 2 × servomotor SIMOTICS S-1FL6 Low Inertia	<b>6AG1067-1AA32-0AA0</b>

## Function

### *Optimized servo performance - quick, smooth and precise positioning*

#### Advanced one-button tuning and real-time auto tuning

Control loop parameters are optimized automatically. One-button tuning can be used when commissioning.

This allows machines to achieve a high dynamic performance and smooth operation in a wide range of applications.

#### Automatic suppression of machine resonances

When this function is activated the drive identifies mechanical resonance frequencies and automatically suppresses these using a filter. Vibration and noise during operation are reduced. This ensures a high dynamic response of the machine while decreasing machine vibration levels.

#### Sufficient encoder resolution and high data transfer rates

The encoder is available up to 21-bit resolution (approx. 2.1 billion pulses per motor rotation).

Fast data transfer:

- Signaling rate up to 1 MHz (pulse train version)
- 100 Mbit/s transfer rate (PROFINET version)

This allows machines to achieve a high positioning accuracy with low speed ripple.

#### Optimized system performance

Fast acceleration and braking while maintaining smooth operation to ensure high machine productivity.

- 300 % overload capability of drive and motor
- Low motor torque ripple
- Motor and drive are perfectly harmonized

### *Reliable operation - Robust design and safe choice*

#### Suitable for harsh environments

- Wide range of line voltages
  - 200 V ... 240 V 1 AC/3 AC (-15 %/+10 %)
  - 380 V ... 480 V 3 AC, (-15 %/+10 %)
- Coated PCB increases robustness of the drive to cope with harsh environments
- Motor is equipped with high-quality bearings

#### High degree of motor protection

- SIMOTICS S-1FL6 servomotors have degree of protection IP65 as standard
- Oil seal at shaft end as standard
- High-quality metal motor connector (SIMOTICS S-1FL6 High Inertia servomotors)

#### Integrated safety function STO (safe torque off)

The STO function is a standard feature of all SINAMICS V90 servo drives. This function prevents the motor from moving unexpectedly and complies with safety standard SIL 2 according to EN 61508 resp. PL d, Cat 3 according to EN ISO 13849. This safety functionality can be realized without additional components (activation only via terminals of SINAMICS V90, not supported via PROFINET/PROFIsafe).

#### *Complete motion control solutions from Siemens*

SINAMICS V90 System and SIMATIC – Siemens offers comprehensive solutions from a single source for general motion control applications with different SINAMICS application examples.

Siemens application examples comprise the following:

- Ready-to-run application examples including wiring diagram and parameter description
- Sample configuration to connect SINAMICS V90 drives to the appropriate SIMATIC controller – this includes hardware and software, a corresponding wiring example, installation instructions for the S7 project provided, drive parameterization and an HMI sample project

Benefits for the customer:

- An operational project is configured properly
- A motor is quickly made operational
- Basis for a customer-specific configuration
- TIA advantages are optimally leveraged

Can be downloaded free of charge via the Online Support Portal:

[www.siemens.com/sinamics-applications](http://www.siemens.com/sinamics-applications)



## System overview

1

### SINAMICS V90 basic servo drive system

#### Configuration

The following electronic configuring aids and engineering tools are available for the SINAMICS V90 basic servo drive system:

##### *Drive Technology Configurator (DT Configurator) within the Interactive Catalog CA 01*

The Interactive Catalog CA 01 – the offline Industry Mall of Siemens – contains over 100 000 products with approximately 5 million possible drive system product variants. The Drive Technology Configurator (DT Configurator) has been developed to facilitate selection of the correct motor and/or converter from the wide spectrum of drives. It is integrated as a selection tool in Interactive Catalog CA 01.

##### *Online DT Configurator*

In addition, the DT Configurator can be used on the Internet without requiring any installation. The DT Configurator can be found in the Siemens Industry Mall at the following address:

[www.siemens.com/dt-configurator](http://www.siemens.com/dt-configurator)

##### *SINAMICS V-ASSISTANT – Easy-to-use engineering tool for commissioning and diagnostics*

A PC with installed SINAMICS V-ASSISTANT software tool can be connected to SINAMICS V90 via a standard USB port. It is used for setting parameters, test operation, troubleshooting – and has powerful monitoring functions.

SINAMICS V-ASSISTANT can be downloaded free of charge from the SINAMICS V90 Internet page:  
[www.siemens.com/sinamics-v90](http://www.siemens.com/sinamics-v90)

You can find further information about the SINAMICS V-ASSISTANT in the Engineering tools section.

#### Technical specifications

##### *General technical specifications*

##### **SINAMICS V90 servo drive system 200 V ... 240 V 1 AC/3 AC Low Inertia for high dynamic performance**

SINAMICS V90 servo drive	
Line supply and power	200 V ... 240 V 1 AC (–15 % / +10 %), 0.05 kW ... 0.75 kW 200 V ... 240 V 3 AC (–15 % / +10 %), 0.05 kW ... 2 kW
Control mode Pulse train (PTI) version	Positioning with pulse train, internal positioning, speed, torque
Control mode PROFINET (PN) version	Speed control, basic positioner control (EPos)
Degree of protection	IP20
SIMOTICS S-1FL6 servomotors	
Shaft height	20, 30, 40, 50
Rated torque	0.16 ... 6.37 Nm
Rated speed	3000 rpm
Max. speed	5000 rpm
Encoder	<ul style="list-style-type: none"> <li>• Incremental encoder TTL 2500 S/R <sup>1)</sup>;</li> <li>• Absolute encoder 21-bit single-turn</li> <li>• Absolute encoder 20-bit single-turn + 12-bit multi-turn</li> </ul>
Degree of protection	IP65, natural cooling

##### **SINAMICS V90 servo drive system 380 V ... 480 V 3 AC High Inertia for smooth operational performance**

SINAMICS V90 servo drive	
Line supply and power	380 V ... 480 V 3 AC (–15 % / +10 %), 0.4 kW ... 7 kW
Control mode Pulse train (PTI) version	Positioning with pulse train, internal positioning, speed, torque
Control mode PROFINET (PN) version	Speed control, basic positioner control (EPos)
Degree of protection	IP20
SIMOTICS S-1FL6 servomotors	
Shaft height	45, 65, 90
Rated torque	1.27 ... 33.40 Nm
Rated speed	2000 rpm / 3000 rpm
Max. speed	4000 rpm
Encoder	<ul style="list-style-type: none"> <li>• Incremental encoder TTL 2500 S/R;</li> <li>• Absolute encoder 20-bit single-turn + 12-bit multi-turn</li> </ul>
Degree of protection	IP65, natural cooling

#### More information

Detailed information on SINAMICS V90, the latest technical documentation (brochures, dimension drawings, certificates, manuals and operating instructions) is available on the Internet at:  
[www.siemens.com/sinamics-v90](http://www.siemens.com/sinamics-v90)

In addition, the Drive Technology Configurator (DT Configurator) can be used on the Internet. The DT Configurator can be found in the Siemens Industry Mall at the following address:  
[www.siemens.com/dt-configurator](http://www.siemens.com/dt-configurator)

<sup>1)</sup> For very low speed, high accuracy or high dynamic application TTL encoder is not recommended.

Integration

**Pulse train version (PTI)**

- RS485 interface for Modbus RTU/USS to communicate with a PLC

**PROFINET version (PN)**

- 2 RJ45 connectors for PROFINET communication with a PLC

**Status indicator**

- RDY indicates servo ready/alarm state
- COM indicates communication with PC

**Integrated operator panel**

- 6 digits, 7-segment LED
- 5 buttons

**High-quality connectors**

**Standard mini USB socket**

- To connect a PC with engineering

**SD card slot**

- To copy parameters
- Standard SD card slot (SINAMICS V90, 400 V version)
- Micro SD card slot (SINAMICS V90, 200 V version)

**Safe Torque Off**

**Motor holding brake** (only SINAMICS V90, 400 V version)

**Control/status interface**

**Pulse train version (PTI) Setpoint interface**

- 50 pins
- Pulse train input
- Encoder emulation pulse output
- DI/DO, AI/AO
- Motor holding brake<sup>1)</sup> (only SINAMICS V90, 200 V version)

**PROFINET version (PN) I/O interface**

- 20 pins
- DI/DO
- Motor holding brake<sup>1)</sup> (only SINAMICS V90, 200 V version)

**Motor encoder connector**

**Braking resistor**

- If the internal braking resistor is not sufficient, disconnect DCP and R2, then connect DCP and R1 with an external braking resistor

**Shield plate**

- Easy shield connection to cables and improved EMC behavior

**SIMOTICS S-1FL6, High Inertia**

- High-quality metal connector
- IP65 degree of protection standard for all motors
- High-quality bearings
- High-wear-resistant oil seal material
- Shaft sleeve protection

G\_D011\_EN\_00479b

**SIMOTICS S-1FL6, Low Inertia**

- Compact cable connection
- IP65 degree of protection standard for all motors
- High-quality bearings
- High-wear-resistant oil seal material

G\_D011\_EN\_00482b

# System overview

## SINAMICS V90 basic servo drive system

### Integration (continued)

#### System connection diagram for SINAMICS V90 pulse train version

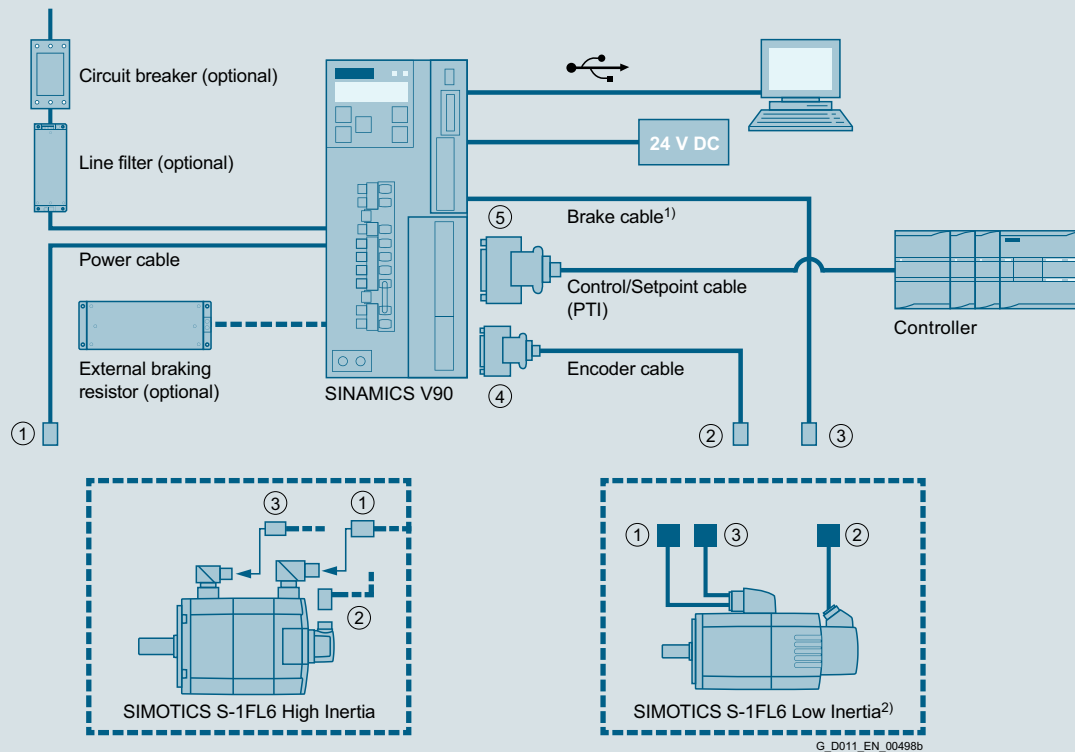

- <sup>1</sup>) Brake cable connection shown here is for SINAMICS V90 400 V version only. The SINAMICS V90 200 V version requires an external relay to connect the motor brake cable. The relay has to be connected via the setpoint cable for the SINAMICS V90 pulse train version. For more information, refer to the SINAMICS V90 operating instructions.
- <sup>2</sup>) SIMOTICS S-1FL6 Low Inertia servomotors in shaft heights 20/30/40 use outlet connection concept with pre-mounted cable end and plastic connection plug-in system.

- ① Power connector (motor side)
- ② Encoder connector (motor side)
- ③ Brake connector (motor side)
- ④ Encoder connector (drive side)
- ⑤ Setpoint connector

## Integration (continued)

## System connection diagram for SINAMICS V90 PROFINET version

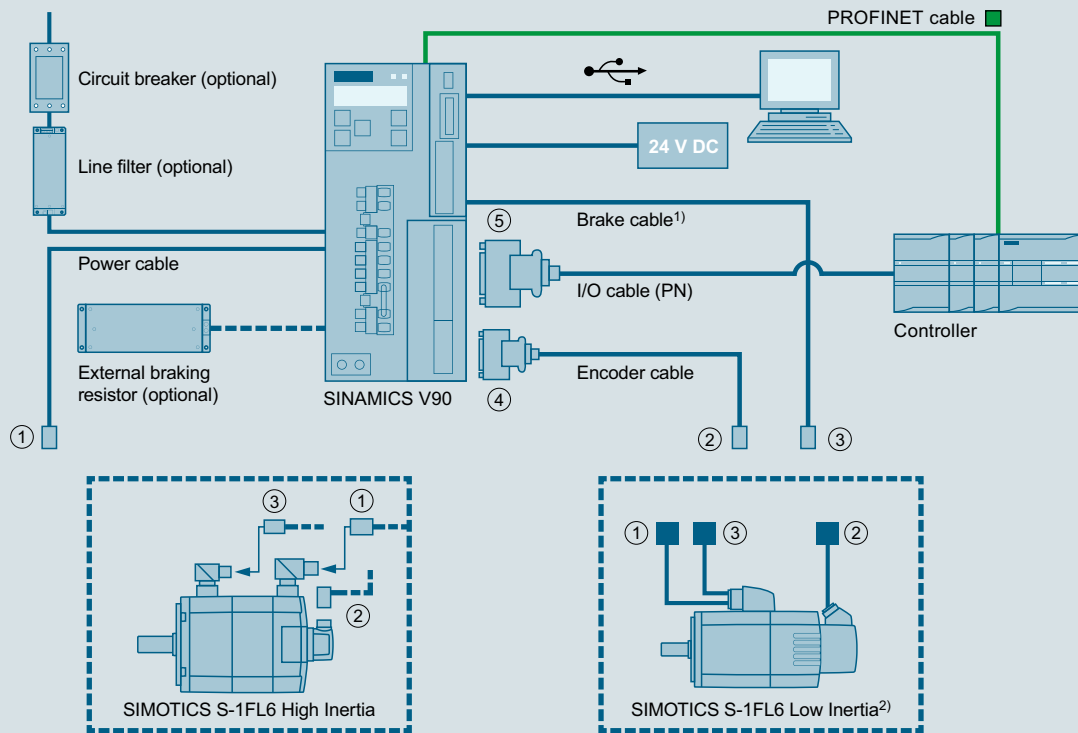

- <sup>1</sup>) Brake cable connection shown here is for SINAMICS V90 400 V version only. The SINAMICS V90 200 V version requires an external relay to connect the motor brake cable. The relay has to be connected via I/O cable for the SINAMICS V90 PROFINET version. For more information, refer to the SINAMICS V90 operating instructions.
- <sup>2</sup>) SIMOTICS S-1FL6 Low Inertia servomotors in shaft heights 20/30/40 use outlet connection concept with pre-mounted cable end and plastic connection plug-in system.

- ① Power connector (motor side)  
 ② Encoder connector (motor side)  
 ③ Brake connector (motor side)  
 ④ Encoder connector (drive side)  
 ⑤ I/O connector

## System overview

1

### SINAMICS V90 Starter Kit

#### Overview

The SINAMICS V90 Starter Kit can be perfectly combined with the SIMATIC Starter Kits. This allows to quickly implement basic drive tasks through to Motion Control applications.

#### Benefits

- Easy entry in the world of SINAMICS drives
- The major components required for operation are already included
- One article number

#### Selection and ordering data

Description	Article No.
SINAMICS V90 Starter Kit with SIMOTICS S-1FL6 Low Inertia Scope of delivery <ul style="list-style-type: none"> <li>• SINAMICS V90 PROFINET version 0.4 kW frame size FSB without filter</li> <li>• SIMOTICS S-1FL6 0.4 kW, shaft height 30, TTL encoder, without brake</li> <li>• Power and signal cable, length: 3 m (9.84 ft)</li> <li>• I/O cable, length: 1 m (3.28 ft)</li> </ul>	<b>6SL3200-0AE40-0AA0</b>



## Selection and ordering data

## Recommended controller for SINAMICS V90 pulse train (PTI) version – pulse train (PTI), Modbus RTU or USS

SIMATIC S7-1200 Basic Controller for SINAMICS V90 pulse train (PTI) version							
Compact CPU expandable with Signal board or communication board	Communication modules	Signal Modules	Digital outputs	of which high-speed outputs (Pulse Train Output)	Work memory	CPU	Article No.
1	3	–	4	4 (100 kHz)	50 KB	CPU 1211C DC/DC/DC	<b>6ES7211-1AE40-0XB0</b>
		2	6	4 (100 kHz)	75 KB	CPU 1212C DC/DC/DC	<b>6ES7212-1AE40-0XB0</b>
		8	10	4 (100 kHz)	100 KB	CPU 1214C DC/DC/DC	<b>6ES7214-1AG40-0XB0</b>
					125 KB	CPU 1215C DC/DC/DC	<b>6ES7215-1AG40-0XB0</b>
					4 (1 MHz)	150 KB	CPU 1217C DC/DC/DC

One SIMATIC S7-1200 CPU can control up to 4 SINAMICS V90 axes. Each axis requires 2 high-speed digital outputs for the pulse train interface. The SIMATIC S7-1500 compact CPUs can also be connected to SINAMICS V90 via "pulse train".

Expansion for Modbus RTU and USS			Expansion for control of more than 2 axes			
For serial data exchange via point-to-point connection			Signal boards, 0.1 A, 200 kHz, can be plugged directly into the CPU. One axis requires 2 high-speed digital outputs for controlling.			
Designation	Type	Article No.	Digital outputs	Input voltage	Type	Article No.
Communication Board RS485, can be plugged directly into the CPU	CB 1241	<b>6ES7241-1CH30-1XB0</b>	2	5 V DC	SB 1223	<b>6ES7223-3AD30-0XB0</b>
				24 V DC		<b>6ES7223-3BD30-0XB0</b>
Communication Module RS422/RS485	CM 1241	<b>6ES7241-1CH32-0XB0</b>	4	5 V DC	SB 1222	<b>6ES7222-1AD30-0XB0</b>
				24 V DC		<b>6ES7222-1BD30-0XB0</b>

## Recommended controller for SINAMICS V90 PROFINET (PN) version

Version	Integrated interfaces	PROFINET	PROFIBUS DP	CPU Processing times for bit operations	Max. number of axes	Work memory	CPU	Article No.
SIMATIC S7-1200 Basic Controller for SINAMICS V90 PROFINET (PN) version								
Standard CPUs	1 × PN IO	–	–	85 ns	2	50 KB	CPU 1211C DC/DC/DC	<b>6ES7211-1AE40-0XB0</b>
		–	–	85 ns	2	75 KB	CPU 1212C DC/DC/DC	<b>6ES7212-1AE40-0XB0</b>
		–	–	85 ns	2	100 KB	CPU 1214C DC/DC/DC	<b>6ES7214-1AG40-0XB0</b>
		–	–	85 ns	2	125 KB	CPU 1215C DC/DC/DC	<b>6ES7215-1AG40-0XB0</b>
		–	–	85 ns	2	150 KB	CPU 1217C DC/DC/DC	<b>6ES7217-1AG40-0XB0</b>
	1 × PN IO (2-port switch)	–	–	85 ns	2	125 KB	CPU 1215C DC/DC/DC	<b>6ES7215-1AG40-0XB0</b>
		–	–	85 ns	2	150 KB	CPU 1217C DC/DC/DC	<b>6ES7217-1AG40-0XB0</b>
SIMATIC S7-1500 Advanced Controller for SINAMICS V90 PROFINET (PN) version								
Standard CPUs	1 × PN IO IRT (2-port switch)	–	–	60 ns	10	150 KB	CPU 1511-1 PN	<b>6ES7511-1AK02-0AB0</b>
		–	–	40 ns	10	300 KB	CPU 1513-1 PN	<b>6ES7513-1AL02-0AB0</b>
		1 × PN	–	30 ns	30	500 KB	CPU 1515-2 PN	<b>6ES7515-2AM01-0AB0</b>
		1 × PN	1 × DP	10 ns	30	1 MB	CPU 1516-3 PN/DP	<b>6ES7516-3AN01-0AB0</b>
		1 × PN	1 × DP	2 ns	96	2 MB	CPU 1517-3 PN/DP	<b>6ES7517-3AP00-0AB0</b>
	2 × PN	1 × DP	1 ns	128	4 MB	CPU 1518-4 PN/DP	<b>6ES7518-4AP00-0AB0</b>	
Compact CPUs	1 × PN IO IRT (2-port switch)	–	–	60 ns	10	175 KB	CPU 1511C-1 PN	<b>6ES7511-1CK01-0AB0</b>
		–	–	48 ns	10	250 KB	CPU 1512C-1 PN	<b>6ES7512-1CK01-0AB0</b>
Technology CPUs	1 × PN IO IRT (2-port switch)	–	–	60 ns	10	225 KB	CPU 1511T-1 PN	<b>6ES7511-1TK01-0AB0</b>
		1 × PN	–	30 ns	30	750 KB	CPU 1515T-2 PN	<b>6ES7515-2TM01-0AB0</b>
		1 × PN	1 × DP	10 ns	80	1.5 MB	CPU 1516T-3 PN/DP	<b>6ES7516-3TN00-0AB0</b>
	1 × PN	1 × DP	2 ns	128	3 MB	CPU 1517T-3 PN/DP	<b>6ES7517-3TP00-0AB0</b>	
Fail-safe CPUs	1 × PN IO IRT (2-port switch)	–	–	60 ns	10	225 KB	CPU 1511F-1 PN	<b>6ES7511-1FK02-0AB0</b>
		–	–	40 ns	10	450 KB	CPU 1513F-1 PN	<b>6ES7513-1FL02-0AB0</b>
		1 × PN	–	30 ns	30	750 KB	CPU 1515F-2 PN	<b>6ES7515-2FM01-0AB0</b>
		1 × PN	1 × DP	10 ns	30	1.5 MB	CPU 1516F-3 PN/DP	<b>6ES7516-3FN01-0AB0</b>
		1 × PN	1 × DP	2 ns	96	3 MB	CPU 1517F-3 PN/DP	<b>6ES7517-3FP00-0AB0</b>
	2 × PN	1 × DP	1 ns	128	6 MB	CPU 1518F-4 PN/DP	<b>6ES7518-4FP00-0AB0</b>	
Fail-safe Technology CPUs	1 × PN IO IRT (2-port switch)	–	–	60 ns	10	225 KB	CPU 1511TF-1 PN	<b>6ES7511-1UK01-0AB0</b>
		1 × PN	–	30 ns	14	750 KB	CPU 1515TF-2 PN	<b>6ES7515-2UM01-0AB0</b>
		1 × PN	1 × DP	10 ns	80	1.5 MB	CPU 1516TF-3 PN/DP	<b>6ES7516-3UN00-0AB0</b>
		1 × PN	1 × DP	2 ns	128	3 MB	CPU 1517TF-3 PN/DP	<b>6ES7517-3UP00-0AB0</b>

For SINAMICS V90 PROFINET (PN) version, the AC/DC/RLY and DC/DC/RLY versions of SIMATIC S7-1200 are also possible (CPU 1211C, CPU 1212C, CPU 1214C and CPU 1215C).

SINAMICS V90 as a PROFINET I/O device with PROFIdrive supports technology objects and function blocks of SIMATIC S7-1200, SIMATIC S7-1500 and SIMATIC S7-1500 Technology CPU for speed and positioning control.

For further information about SIMATIC controllers please refer to Catalog ST 70 or to web page: [www.siemens.com/simatic-controller](http://www.siemens.com/simatic-controller)

## System overview

Notes

1

## SINAMICS V90 servo drive



<b>2/2</b>	<b>SINAMICS V90 servo drive</b>
2/2	Overview
2/2	Benefits
2/3	Function
2/4	Integration
2/5	Technical specifications
2/7	Dimensional drawings
<b>2/10</b>	<b>Line filters</b>
2/10	Overview
<b>2/10</b>	<b>Recommended line-side overcurrent protection devices</b>
2/10	Overview
<b>2/10</b>	<b>External braking resistor</b>
2/10	Overview
<b>2/10</b>	<b>Connecting cables for SIMATIC S7 controller</b>
2/10	Overview
<b>2/10</b>	<b>Supplementary system components</b>
2/10	Overview

For **selection and ordering data** please refer to section "System overview" "SINAMICS V90 basic servo drive system" from page 1/10.

Detailed technical information on SINAMICS V90 is available on the Internet at:  
[www.siemens.com/sinamics-v90/documentation](http://www.siemens.com/sinamics-v90/documentation)

In addition, the Drive Technology Configurator (DT Configurator) can be used on the Internet at the following address:  
[www.siemens.com/dt-configurator](http://www.siemens.com/dt-configurator)

## SINAMICS V90 servo drive

### SINAMICS V90 servo drive

#### Overview

#### *SINAMICS V90 - optimized servo drive solution for motion control applications*



SINAMICS V90 servo drive, 200 ... 240 V 1 AC/3 AC, frame sizes FSA, FSB, FSC and FSD

#### SINAMICS V90 servo drive

SINAMICS V90 can be integrated into a wide range of applications, either using the pulse train version (pulse/direction, analog, USS/Modbus RTU) or the PROFINET version.

The SINAMICS V90 pulse train version features internal positioning, positioning with pulse train as well as speed and torque control modes.

The SINAMICS V90 PROFINET version supports PROFINET for linking the drive to an automation system via PROFIdrive profile.



SINAMICS V90 servo drive, 380 ... 480 V 3 AC, frame sizes FSA, FSB and FSC

With integrated real-time auto tuning and automatic suppression of machine resonances, the system automatically optimizes itself to achieve high dynamic performance and smooth operation.

For Selection and Ordering Data please refer to section "System overview" "SINAMICS V90 basic servo drive system" from page 1/10.

#### Benefits

##### Optimized servo performance

- Advanced one-button tuning and real-time auto tuning enable machines to achieve a high dynamic performance
- Automatic suppression of machine resonances
- 1 MHz high-frequency pulse train input
- Different encoder types to address the requirements of your applications

##### Cost-effective

- Integrated control modes: Pulse train positioning, internal positioning with traversing block or Modbus, speed and torque control modes
- Integrated internal positioning function
- Integrated braking resistor in all frame sizes with max. motor power  $\geq 0.2$  kW
- Integrated holding brake switch (for the 400 V version), no external relay necessary

##### Easy to use

- Simple connection to a control system
- Easy, all from a single source
- Easy servo tuning
- Easy machine optimization
- Easy commissioning with SINAMICS V-ASSISTANT
- Parameter cloning
- Easy integration via PTI, PROFINET, USS, Modbus RTU

##### Reliable operation

- High-quality motor bearings
- All motors have IP65 degree of protection and are equipped with oil seal
- Integrated safe torque off (STO)

## Function

		SINAMICS V90 Pulse train version (PTI)	SINAMICS V90 PROFINET version (PN)
<b>Control modes</b>			
<b>Control modes</b>		<ul style="list-style-type: none"> <li>Pulse train input position control (PTI)</li> <li>Internal position control (IPos), setpoints selected using a combination of digital inputs, or Modbus/US\$</li> <li>Speed control (S)</li> <li>Torque control (T)</li> <li>Compound controls, switches between position control, speed control, and torque control</li> <li>Jog using buttons on the integrated operator panel</li> </ul>	<ul style="list-style-type: none"> <li>Speed control mode: position and speed control in combination with a motion function (TO axis) of SIMATIC S7-1500/S7-1200 and PROFINET</li> <li>Basic positioner control (EPos)</li> </ul>
<b>Speed control</b>	Speed input	External analog input or internal speed setpoint	PROFINET or internal speed setpoint
	Torque limit	External analog input or set using a parameter	PROFINET or set using a parameter
<b>Pulse train input position control</b>	Max. pulse frequency	<ul style="list-style-type: none"> <li>Differential line driver (5 V), 1 MHz</li> <li>Optical coupler (24 V), 200 kHz</li> </ul>	–
	Multiplying factor	Electronic gear ratio (A/B), A:1-65535, B:1-65535, 1/50<A/B<200	–
	Torque limit	External analog input or set using a parameter	–
<b>Torque control mode</b>	Torque input	External analog input or internal torque setpoint	–
	Speed limit	Prevents speed limits from being violated, set using a parameter for analog input	Set using a parameter
<b>Control features</b>			
<b>Real time auto tuning</b>	Estimates the machine characteristic and sets the closed-loop control parameters (gain, integral time, etc.) continuously in real time without any user intervention		
<b>Resonance suppression</b>	Suppresses mechanical resonance, such as workpiece and foundation vibration		
<b>One-button auto tuning</b>	Estimates the machine load inertia and mechanical characteristics with internal movement command (pre-configured for SINAMICS V90) This feature can be initiated using the SINAMICS V-ASSISTANT engineering tool.		
<b>Gain switch and PI/P switch</b>	Switches between gains or from PI to P control using an external signal or internal operating conditions		
<b>Torque limit</b>	Limits motor speed using an external analog input or internal torque limit		Motor torque is internally limited
<b>Travel to fixed stop</b>	Can be used to move an axis to a fixed stop at a specified torque without a signal fault		
<b>DI/DO parameterization</b>	Freely assigns the control signals to digital inputs and digital outputs		
<b>External braking resistor</b>	An external braking resistor can be used when the internal braking resistor is not capable of handling the regenerative energy.		
<b>Measure machine</b>	The machine frequency characteristics are analyzed using SINAMICS V-ASSISTANT		
<b>Parameter cloning and Firmware update</b>	Optionally via memory card <ul style="list-style-type: none"> <li>For 400 V version: SD card; recommended SINAMICS SD card</li> <li>For 200 V version: Micro SD card</li> <li>Maximum supported capacity: 32 GB</li> </ul>		
<b>Safety functions</b>	Safe Torque Off (STO) via terminal, complies with safety standard SIL 2 according to EN 61508 resp. PL d, Cat 3 according to EN ISO 13849 (activation only via terminals of SINAMICS V90, not supported via PROFINET/PROFIsafe)		
<b>Basic Operator Panel (BOP)</b>	Integrated, 6-digit/7-segment display, 5 buttons		
<b>Engineering PC tool</b>	<ul style="list-style-type: none"> <li>SINAMICS V-ASSISTANT engineering tool exclusively for SINAMICS V90</li> <li>SINAMICS V90 in combination with S7-1500 and STEP 7 Professional engineering via TIA Portal V14 possible.</li> </ul>		



# SINAMICS V90 servo drive

## SINAMICS V90 servo drive

### Integration

2

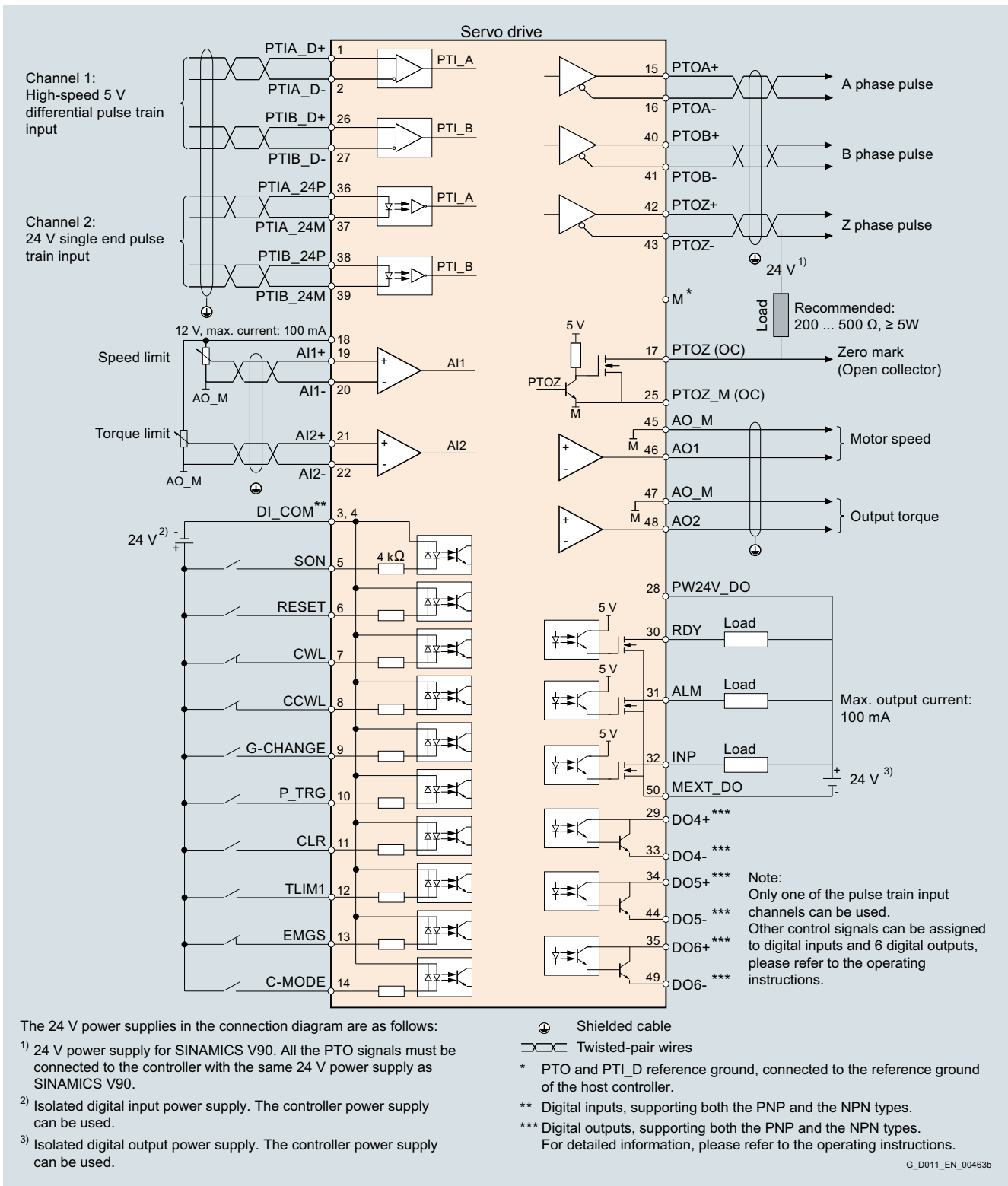

Standard wiring for pulse train input (PTI) position control mode (for detailed information and connection diagram for other control modes, please refer to the operating instructions). The diagram is given as a reference for selecting the drive type.

When commissioning the selected servo drive system, establish the wiring connections according to the connection diagram and the instructions provided in the operating instructions.

## Technical specifications

### General technical specifications

SINAMICS V90 servo drive	
<b>Control power supply</b>	
• Voltage	24 V DC (-15 %/+20 %) When SINAMICS V90 controls a motor equipped with brake, the tolerance of the 24 V DC power supply must be -10 % to +10 % to comply with the voltage required by the brake.
• Current <sup>1)</sup>	
-without holding brake	1.6 A
-with holding brake	1.6 A + rated current motor holding brake <a href="#">For more information please refer to section „SIMOTICS S-1FL6 servomotors“ „Technical Data“ from page 3/3.</a>
<b>Line supply system</b>	TN, TT, IT, TT earthed line
<b>Overload capacity</b>	300 % × rated current for 300 ms every 10 s
<b>Control system</b>	Servo control
<b>Braking resistor</b>	Integrated for all frame sizes with max. motor power ≥ 0.2 kW
<b>Ambient temperature</b>	
• Operation	0 ... 45 °C (32 ... 113 °F) 45 ... 55 °C (113 ... 131 °F) with derating
• Storage	-40 ... +70 °C (-40 ... +158 °F)
<b>Ambient humidity</b>	
• Operation	<90 % (no condensation)
• Storage	90 % (no condensation)
<b>Pollution class</b>	2
<b>Vibration</b>	
• Operation	Operational area II 10 Hz ... 58 Hz: 0.075 mm deflection 58 Hz ... 200 Hz: 1 g vibration
• Product packaging	2 Hz ... 9 Hz: 3.5 mm deflection 9 Hz ... 200 Hz: 1 g vibration Quantity of cycles: 10 per axis Sweep speed: 1 octave/min
<b>Shock</b>	Operational area II Peak acceleration: 5 g, 30 ms; 15 g, 11 ms Quantity of shocks: 3 per direction × 6 directions Duration of shock: 1 s
<b>Degree of protection</b>	IP20
<b>Installation altitude</b>	Up to 1000 m (3281 ft) above sea level without derating, > 1000 m ... 5000 m (> 3281 ft ... 16405 ft) with derating
<b>Standards</b>	CE, KC, EAC, cULus, RCM

<sup>1)</sup> SINAMICS V90 PROFINET version requires a 24 V DC supply with max. 1.5 A (without a holding brake), or 3.5 A (with a holding brake). Refer to the operating instructions for detailed information.

## SINAMICS V90 servo drive

## SINAMICS V90 servo drive

## Technical specifications (continued)

Line voltage 200 ... 240 V 1 AC/3 AC		SINAMICS V90 servo drive						
<b>Pulse train version:</b>	6SL3210-5F...	B10-1UA2	B10-2UA2	B10-4UA1	B10-8UA0	B11-0UA1	B11-5UA0	B12-0UA0
<b>PROFINET version:</b>	6SL3210-5F...	B10-1UF2	B10-2UF2	B10-4UF1	B10-8UF0	B11-0UF1	B11-5UF0	B12-0UF0
<b>Frame size</b>		FSA	FSA	FSB	FSC	FSD	FSD	FSD
<b>Max. motor power</b>	kW	0.1	0.2	0.4	0.75	1	1.5	2
<b>Output current</b>								
• Rated current $I_{rated}$	A	1.2	1.4	2.6	4.7	6.3	10.6	11.6
• Max. current $I_{max}$	A	3.6	4.2	7.8	14.1	18.9	31.8	34.8
<b>Line supply voltage</b>		200 ... 240 V 1 AC/3 AC -15 %/+10 %	200 ... 240 V 1 AC/3 AC -15 %/+10 %	200 ... 240 V 1 AC/3 AC -15 %/+10 %	200 ... 240 V 1 AC/3 AC -15 %/+10 %	200 ... 240 V 3 AC -15 %/+10 %	200 ... 240 V 3 AC -15 %/+10 %	200 ... 240 V 3 AC -15 %/+10 %
<b>Line frequency</b>	Hz	50/60 -10 %/+10 %	50/60 -10 %/+10 %	50/60 -10 %/+10 %	50/60 -10 %/+10 %	50/60 -10 %/+10 %	50/60 -10 %/+10 %	50/60 -10 %/+10 %
<b>Line supply capacity</b>								
• 1 AC	kVA	0.5	0.7	1.2	2	–	–	–
• 3 AC	kVA	0.5	0.7	1.1	1.9	2.7	4.2	4.6
<b>Cooling</b>		Natural cooling	Natural cooling	Natural cooling	Natural cooling	Fan cooling	Fan cooling	Fan cooling
<b>Dimensions</b>								
• Width	mm (in)	45 (1.77)	45 (1.77)	55 (2.17)	80 (3.15)	95 (3.74)	95 (3.74)	95 (3.74)
• Height	mm (in)	170 (6.69)	170 (6.69)	170 (6.69)	170 (6.69)	170 (6.69)	170 (6.69)	170 (6.69)
• Depth	mm (in)	170 (6.69)	170 (6.69)	170 (6.69)	195 (7.68)	195 (7.68)	195 (7.68)	195 (7.68)
<b>Weight, approx.</b>	kg (lb)	1.07 (2.4)	1.07 (2.4)	1.20 (2.6)	1.94 (4.3)	2.49 (5.5)	2.49 (5.5)	2.49 (5.5)

Line voltage 380 ... 480 V 3 AC		SINAMICS V90 servo drive							
<b>Pulse train version:</b>	6SL3210-5F...	E10-4UA0	E10-8UA0	E11-0UA0	E11-5UA0	E12-0UA0	E13-5UA0	E15-0UA0	E17-0UA0
<b>PROFINET version:</b>	6SL3210-5F...	E10-4UF0	E10-8UF0	E11-0UF0	E11-5UF0	E12-0UF0	E13-5UF0	E15-0UF0	E17-0UF0
<b>Frame size</b>		FSAA	FSA	FSA	FSB	FSB	FSC	FSC	FSC
<b>Max. motor power</b>	kW	0.4	0.75	1	1.75	2.5	3.5	5	7
<b>Output current</b>									
• Rated current $I_{rated}$	A	1.2	2.1	3	5.3	7.8	11	12.6	13.2
• Max. current $I_{max}$	A	3.6	6.3	9	15.9	23.4	33	37.8	39.6
<b>Line supply voltage</b>		380 ... 480 V 3 AC -15 %/+10 %	380 ... 480 V 3 AC -15 %/+10 %	380 ... 480 V 3 AC -15 %/+10 %	380 ... 480 V 3 AC -15 %/+10 %	380 ... 480 V 3 AC -15 %/+10 %	380 ... 480 V 3 AC -15 %/+10 %	380 ... 480 V 3 AC -15 %/+10 %	380 ... 480 V 3 AC -15 %/+10 %
<b>Line frequency</b>	Hz	50/60 -10 %/+10 %	50/60 -10 %/+10 %	50/60 -10 %/+10 %	50/60 -10 %/+10 %	50/60 -10 %/+10 %	50/60 -10 %/+10 %	50/60 -10 %/+10 %	50/60 -10 %/+10 %
<b>Line supply capacity</b>	kVA	1.7	3	4.3	6.6	11.1	15.7	18	18.9
<b>Cooling</b>		Natural cooling	Natural cooling	Natural cooling	Natural cooling	Fan cooling	Fan cooling	Fan cooling	Fan cooling
<b>Dimensions</b>									
• Width	mm (in)	60 (2.36)	80 (3.15)	80 (3.15)	100 (3.94)	100 (3.94)	140 (5.51)	140 (5.51)	140 (5.51)
• Height	mm (in)	180 (7.09)	180 (7.09)	180 (7.09)	180 (7.09)	180 (7.09)	260 (10.24)	260 (10.24)	260 (10.24)
• Depth	mm (in)	200 (7.87)	200 (7.87)	200 (7.87)	220 (8.66)	220 (8.66)	240 (9.45)	240 (9.45)	240 (9.45)
<b>Weight, approx.</b>	kg (lb)	1.45 (3.2)	2.09 (4.6)	2.09 (4.6)	2.73 (6.0)	2.73 (6.0)	5.95 (13.1)	5.95 (13.1)	5.95 (13.1)

Interfaces		SINAMICS V90 Pulse train version (PTI)	SINAMICS V90 PROFINET version (PN)
<b>USB</b>		Mini USB	Mini USB
<b>Pulse train input</b>		2 channels, one exclusively for 5 V differential signal, one for 24 V single end signal	–
<b>Pulse train encoder output</b>		5 V differential signal, A, B, Z phase	–
<b>Digital inputs/outputs</b>		10 inputs, NPN/PNP; 6 outputs, NPN	4 inputs, NPN/PNP; 2 outputs, NPN/PNP
<b>Analog outputs</b>		2 analog outputs, output voltage range $\pm 10$ V, 10 bit	–
<b>Communication</b>		USS/Modbus RTU (RS485)	PROFINET RT/IRT interface with 2 ports (RJ45 sockets)
<b>SD card slot</b>		<ul style="list-style-type: none"> <li>Standard SD card with 400 V version</li> <li>Micro SD card with 200 V version</li> </ul>	<ul style="list-style-type: none"> <li>Standard SD card with 400 V version</li> <li>Micro SD card with 200 V version</li> </ul>
<b>Safety functions</b>		Safe Torque Off (STO) via terminal, SIL 2	Safe Torque Off (STO) via terminal, SIL 2

**Dimensional drawings**

Dimensions in mm

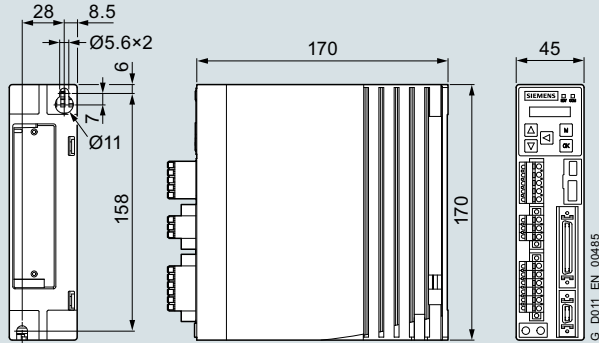

SINAMICS V90, 200 ... 240 V 1 AC/3 AC, frame size FSA

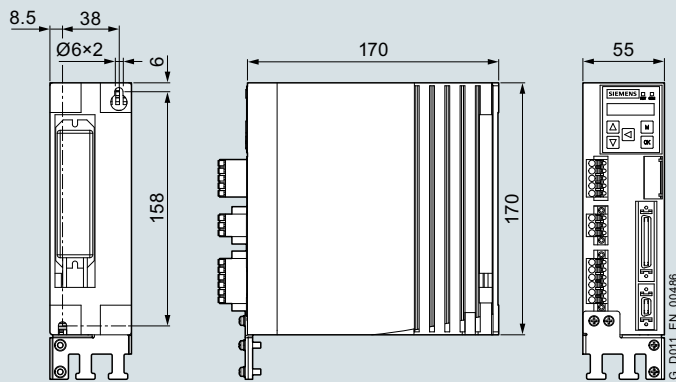

SINAMICS V90, 200 ... 240 V 1 AC/3 AC, frame size FSB

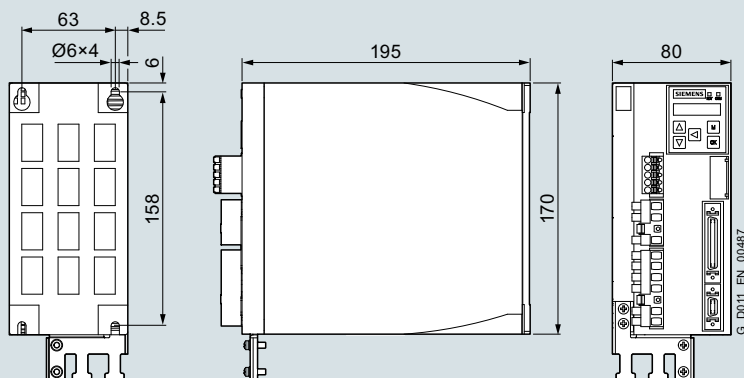

SINAMICS V90, 200 ... 240 V 1 AC/3 AC, frame size FSC

# SINAMICS V90 servo drive

## SINAMICS V90 servo drive

### Dimensional drawings (continued)

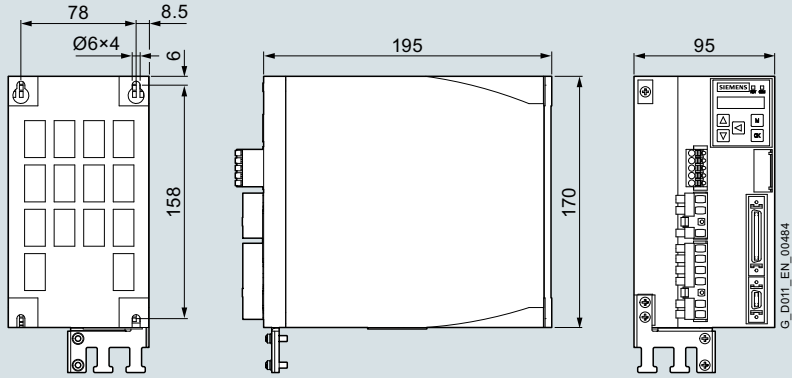

SINAMICS V90, 200 ... 240 V 3 AC, frame size FSD

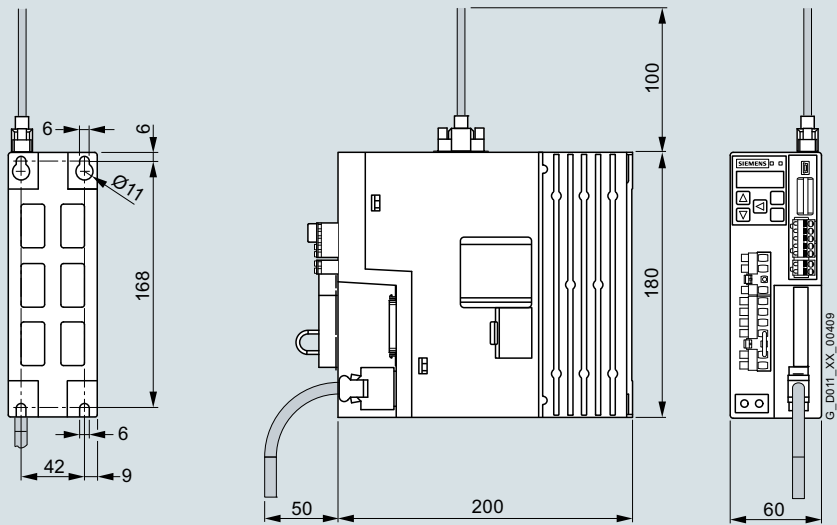

SINAMICS V90, 380 ... 480 V 3 AC, frame size FSAA

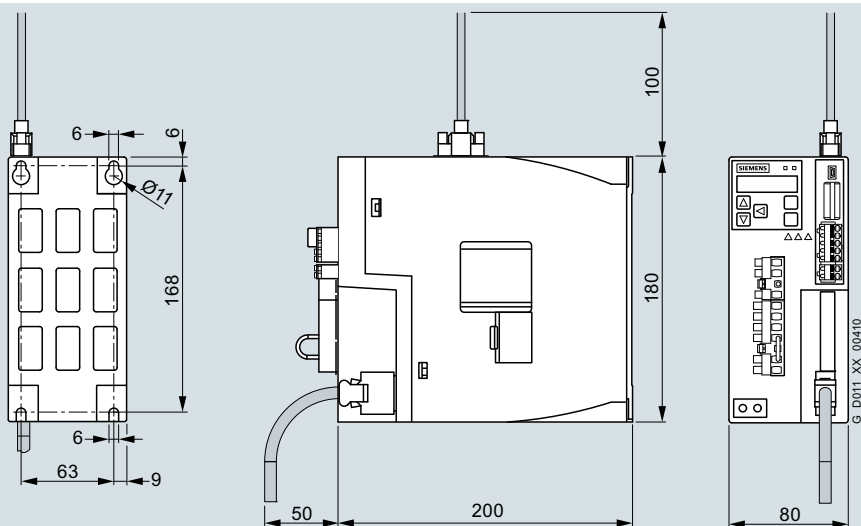

SINAMICS V90, 380 ... 480 V 3 AC, frame size FSA

Dimensional drawings (continued)

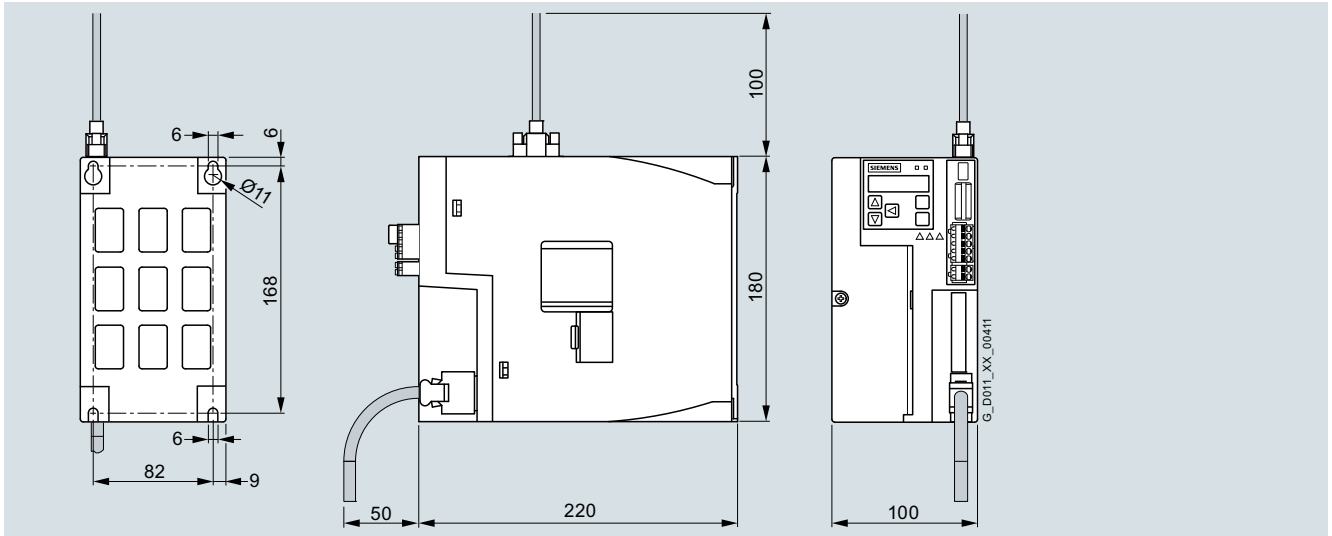

SINAMICS V90, 380 ... 480 V 3 AC, frame size FSB

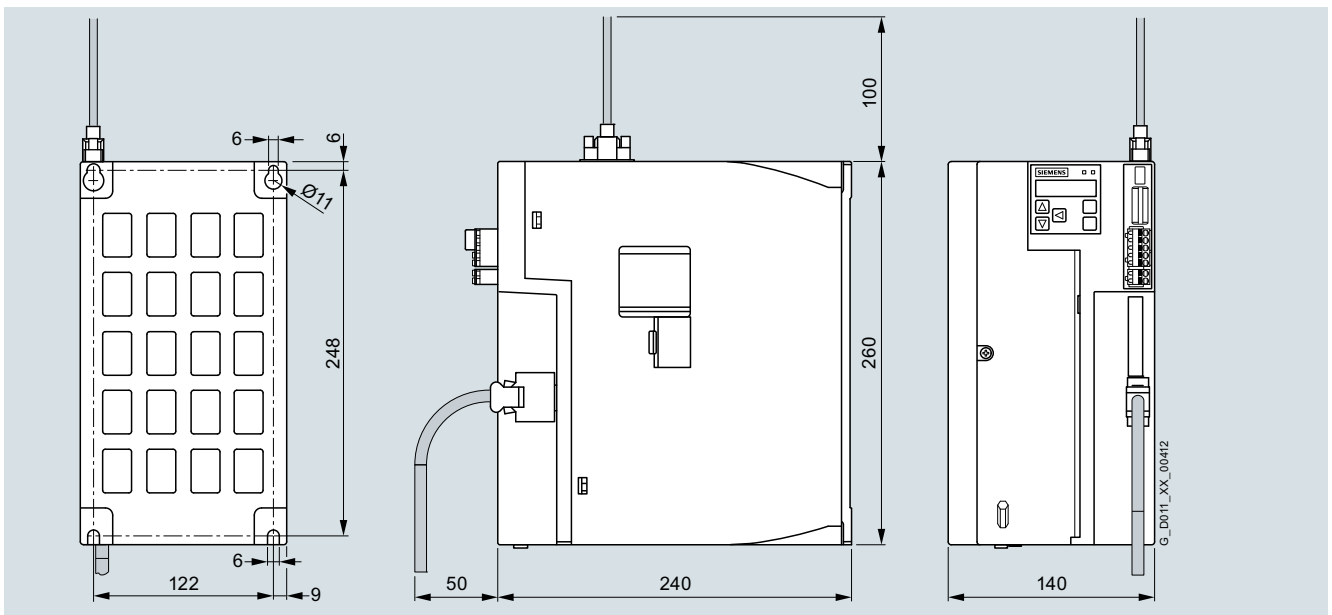

SINAMICS V90, 380 ... 480 V 3 AC, frame size FSC

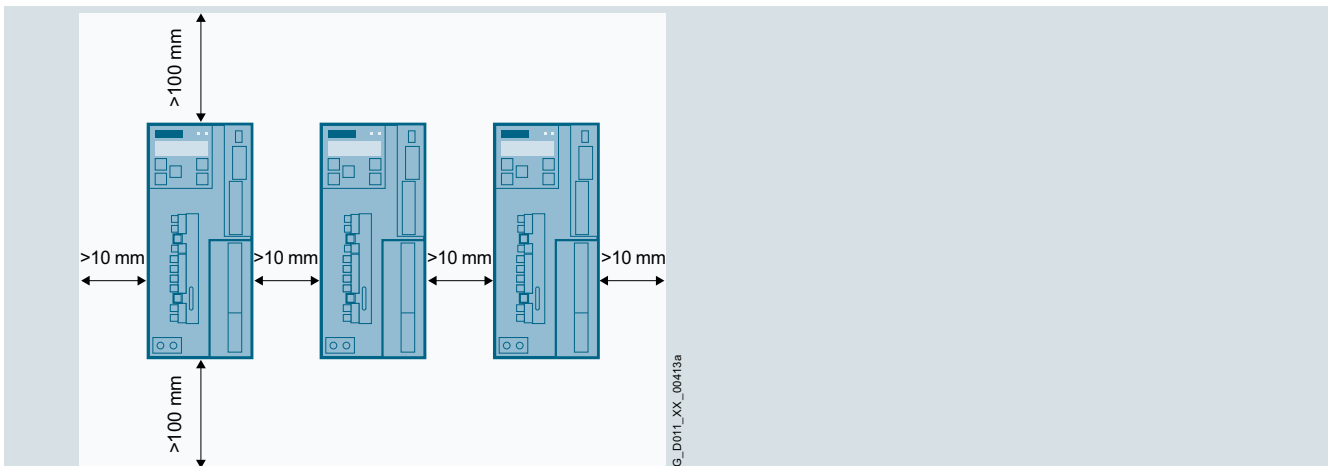

Mounting clearances



## SINAMICS V90 servo drive

### Line filters

#### Overview

It is recommended to use a line filter to protect the system from high frequency noise.

With one of the recommended line filters, EN 61800-3 category C2 can be reached in combination with SINAMICS V90.

For selection and ordering data please refer to section "System overview" "SINAMICS V90 basic servo drive system" from page 1/10.

### Recommended line-side overcurrent protection devices

#### Overview

A fuse/circuit breaker can be used to protect the system.

For selection and ordering data please refer to section "System overview" "SINAMICS V90 basic servo drive system" from page 1/10.

### External braking resistor

#### Overview

When the internal braking resistor cannot meet the braking requirements, an external braking resistor can be used to transform the regenerative electrical energy into heat, thus giving greatly improved braking and deceleration capabilities.

The following table contains the technical data for selecting a standard braking resistor.

Frame size	Resistance $\Omega$	Max. power kW	Rated power W	Max. energy kJ
<b>Line voltage 200 ... 240 V 1 AC/3 AC</b>				
FSA	150	1.09	20	0.8
FSB	100	1.64	21	1.23
FSC	50	3.28	62	2.46
FSD, 1 kW	50	3.28	62	2.46
FSD, 1.5 ... 2 kW	25	6.56	123	4.92
<b>Line voltage 380 ... 480 V 3 AC</b>				
FSAA	533	1.2	30	2.4
FSA	160	4	100	8.0
FSB	70	9.1	229	18.3
FSC	27	23.7	1185	189.6

### Connecting cables for SIMATIC S7 controller

#### Overview

Connecting cables for SIMATIC S7 controller are available for

- SINAMICS V90 pulse train (PTI) version
- SINAMICS V90 PROFINET (PN) version

For selection and ordering data please refer to section "System overview" "SINAMICS V90 basic servo drive system" on page 1/14.

### Supplementary system components

#### Overview

##### Memory card

Optionally an SD card can be used for SINAMICS V90 380 ... 480 V 3 AC variants to copy drive parameters or perform a firmware update. You are recommended to use the SINAMICS SD card.

For selection and ordering data please refer to section "System overview" "SINAMICS V90 basic servo drive system" on page 1/14.

##### Replacement connector kits

Replacement connector kits for the power and signal cables are available for SINAMICS V90.

##### Replacement fans

Replacement fans are available for SINAMICS V90 200 ... 240 V 3 AC frame size FSD and 380 ... 480 V 3 AC frame sizes FSB and FSC.

## SIMOTICS S-1FL6 servomotors



### 3/2 SIMOTICS S-1FL6 servomotors for SINAMICS V90

3/2	Overview
3/2	Benefits
3/2	Application
3/2	Function
3/3	Technical specifications
3/5	Characteristic curves
3/8	Dimensional drawings

For **selection and ordering data** please refer to section "System overview" "SINAMICS V90 basic servo drive system" from page 1/10.

Detailed technical information on SINAMICS V90 is available on the Internet at:  
[www.siemens.com/sinamics-v90/documentation](http://www.siemens.com/sinamics-v90/documentation)

In addition, the Drive Technology Configurator (DT Configurator) can be used on the Internet at the following address:  
[www.siemens.com/dt-configurator](http://www.siemens.com/dt-configurator)

## SIMOTICS S-1FL6 servomotors

### SIMOTICS S-1FL6 servomotors for SINAMICS V90

#### Overview

#### Optimized servomotor solution for motion control applications



SIMOTICS S-1FL6 Low Inertia servomotors

SIMOTICS S-1FL6 servomotors are permanent-magnet synchronous motors and designed for operation without external cooling. The heat is dissipated through the motor surface.

The motors have a 300 % overload capability and can be combined with the SINAMICS V90 servo drives to create a powerful servo system with high functionality. Incremental or absolute encoders can be selected depending on the application.

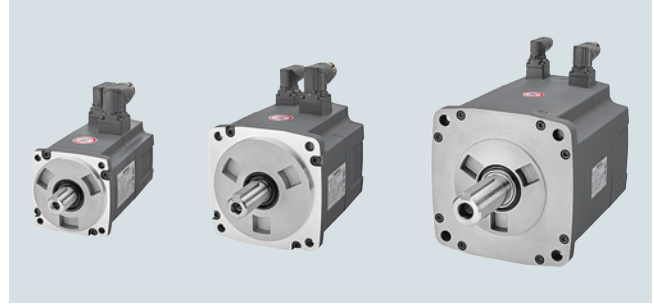

SIMOTICS S-1FL6 High Inertia servomotors

SIMOTICS S-1FL6 motors have a high degree of dynamic performance, wide speed control range and high shaft end and flange precision.

For selection and ordering data please refer to section "System overview" "SINAMICS V90 basic servo drive system" from page 1/10.

3

#### Benefits

- High-performance magnet material
- Rugged design with IP65 degree of protection for complete motor including connectors
- Smooth running quality thanks to low torque ripple
- High rated speed for some variants
- High acceleration due to the 300 % overload capacity
- Rotatable connectors
- Maximum flexibility due to variants with incremental encoder/absolute encoder, with/without brake and plain shaft/feather key

#### Application

##### Typical applications

- Handling machines, e.g. pick & place machines
- Packaging machines, e.g. labeling machines, horizontal packaging machines
- Automatic assembly machines
- Metal forming machines
- Printing machines, e.g. screen printing machines
- Winders and unwinders

#### Function

SIMOTICS S-1FL6 servomotors		
	Low Inertia	High Inertia
Shaft height	20, 30, 40, 50	45, 65, 90
Rated torque	0.16 Nm ... 6.37 Nm	1.27 Nm ... 33.4 Nm
Rated speed	3000 rpm	2000 rpm/3000 rpm
Maximum speed	5000 rpm	4000 rpm
Encoders, integrated	<ul style="list-style-type: none"> <li>• Incremental encoder 2500 S/R</li> <li>• Absolute encoder 21-bit single-turn</li> <li>• Absolute encoder 20-bit single-turn + 12-bit multi-turn</li> </ul>	<ul style="list-style-type: none"> <li>• Incremental encoder 2500 S/R</li> <li>• Absolute encoder 20-bit single-turn + 12-bit multi-turn</li> </ul>
<b>Additional advantages</b>	<ul style="list-style-type: none"> <li>• <b>High dynamic performance</b> High acceleration for shorter cycle times as a result of the very low moment of inertia</li> <li>• <b>High speed</b> Maximum speed up to 5000 rpm can increase machine productivity</li> <li>• <b>Compact size</b> The reduced motor length/height compared to High Inertia variants and compact drive size can address critical mounting requirements.</li> </ul>	<ul style="list-style-type: none"> <li>• <b>Smooth operation</b> Higher torque accuracy and low speed ripple as a result of the higher moment of inertia ensures a better product quality.</li> <li>• <b>Robust design</b> High-quality metal connector and standard motor oil seal can withstand harsh environment.</li> <li>• <b>Sufficient torque output</b> Wide range of rated torques up to 33.4 Nm</li> </ul>

## Technical specifications

### General technical specifications

SIMOTICS S-1FL6 servomotors	
<b>Type of motor</b>	Permanent-magnet synchronous motor
<b>Magnet material</b>	High-performance magnetic material
<b>Cooling</b>	Natural cooling
<b>Insulation of the stator winding in accordance with EN 60034-1 (IEC 60034-1)</b>	Temperature class 130 (B)
<b>Temperature class</b>	B (130 °C/266 °F)
<b>Type of construction in accordance with EN 60034-7 (IEC 60034-7)</b>	IM B5 (IM V1, IM V3)
<b>Degree of protection in accordance with EN 60034-5 (IEC 60034-5)</b>	IP65
<b>Shaft extension in accordance with IEC 60072-1</b>	Plain shaft/feather key (C type)
<b>Shaft and flange accuracy in accordance with IEC 60072-1 <sup>1)</sup></b>	Tolerance N
<b>Vibration severity in accordance with IEC 60034-14</b>	Grade A
<b>Sound pressure level, max.</b>	
• 1FL602	60 dB
• 1FL603	60 dB
• 1FL604	
-Low Inertia	60 dB
-High Inertia	65 dB
• 1FL605	60 dB
• 1FL606	70 dB
• 1FL609	70 dB
<b>Ambient temperature</b>	
• Storage/transport	-20 ... +65 °C (-4 ... +149 °F)
• Operation	
-SIMOTICS S-1FL6 Low Inertia 1FL6052-2AF.../1FL6054-2AF...	0 ... 30 °C (32 ... 86 °F) without derating
-SIMOTICS S-1FL6 Low Inertia 1FL6022/1FL6024/1FL6032/1FL6034/1FL6042/1FL6044	0 ... 40 °C (32 ... 104 °F) without derating
-SIMOTICS S-1FL6 High Inertia	0 ... 40 °C (32 ... 104 °F) without derating
<b>Relative atmospheric humidity</b>	
• Storage/transport	90 % at 30 °C (86 °F) (no condensation)
• Operation	90 % at 30 °C (86 °F) (no condensation)
<b>Installation altitude</b>	Up to 1000 m (3281 ft) above sea level without derating > 1000 m ... 5000 m (3281 ... 16405 ft) with derating
<b>Paint finish</b>	Black
<b>Certificate of suitability</b>	CE, EAC

<sup>1)</sup> Shaft extension run-out, concentricity of centering ring and shaft, and perpendicularity of flange to shaft.

## SIMOTICS S-1FL6 servomotors

## SIMOTICS S-1FL6 servomotors for SINAMICS V90

## Technical specifications (continued)

		SIMOTICS S-1FL6 Low Inertia							
		1FL6022-2AF...	1FL6024-2AF...	1FL6032-2AF...	1FL6034-2AF...	1FL6042-2AF...	1FL6044-2AF...	1FL6052-2AF...	1FL6054-2AF...
<b>Shaft height</b>		20	20	30	30	40	40	50	50
<b>Rated power</b> <sup>1)</sup>	kW	0.05	0.10	0.20	0.40	0.75	1.00	1.50	2.00
	hp	0.07	0.14	0.27	0.54	1.02	1.36	2.04	2.72
<b>Rated torque</b> <sup>1)</sup>	Nm	0.16	0.32	0.64	1.27	2.39	3.18	4.78	6.37
<b>Rated speed</b>	rpm	3000	3000	3000	3000	3000	3000	3000	3000
<b>Maximum torque</b> <sup>1)</sup>	Nm	0.48	0.96	1.91	3.82	7.2	9.54	14.3	19.1
<b>Maximum speed</b>	rpm	5000	5000	5000	5000	5000	5000	5000	5000
<b>Rated current</b>	A	1.2	1.2	1.4	2.6	4.7	6.3	10.6	11.6
<b>Maximum current</b>	A	3.6	3.6	4.2	7.8	14.2	18.9	31.8	34.8
<b>Torque constant</b>	Nm/A	0.14	0.29	0.48	0.49	0.51	0.51	0.46	0.55
<b>Moment of inertia</b>									
• without brake	10 <sup>-4</sup> kgm <sup>2</sup>	0.031	0.052	0.214	0.351	0.897	1.15	2.04	2.62
• with brake	10 <sup>-4</sup> kgm <sup>2</sup>	0.038	0.059	0.245	0.381	1.06	1.31	2.24	2.82
<b>Recommended load to motor inertia ratio, max.</b>		30x	30x	30x	30x	20x	20x	15x	15x
<b>Encoder types</b>		<ul style="list-style-type: none"> <li>• Incremental encoder TTL, 2500 S/R</li> <li>• Absolute encoder 21-bit single-turn</li> <li>• Absolute encoder 20-bit single-turn + 12-bit multi-turn</li> </ul>							
<b>Weight</b> <sup>2)</sup>									
• without brake	kg	0.47	0.63	1.02	1.46	2.8	3.39	5.45	6.66
• with brake	kg	0.70	0.86	1.48	1.92	3.68	4.20	6.96	8.20
<b>Holding brake</b> <sup>3)</sup>									
<b>Holding torque</b>	Nm	0.32	0.32	1.27	1.27	3.18	3.18	6.37	6.37
<b>Rated voltage</b>	V DC	24 ±10 %	24 ±10 %	24 ±10 %	24 ±10 %	24 ±10 %	24 ±10 %	24 ±10 %	24 ±10 %
<b>Opening time</b>	ms	35	35	75	75	105	105	90	90
<b>Closing time</b>	ms	10	10	10	10	15	15	35	35
<b>Rated current</b>	A	0.25	0.25	0.3	0.3	0.35	0.35	0.57	0.57

		SIMOTICS S-1FL6 High Inertia						
		1FL6042-1AF...	1FL6044-1AF...	1FL6061-1AC...	1FL6062-1AC...	1FL6064-1AC...	1FL6066-1AC...	1FL6067-1AC...
<b>Shaft height</b>		45	45	65	65	65	65	65
<b>Rated power</b> <sup>1)</sup>	kW	0.40	0.75	0.75	1.00	1.50	1.75	2.00
	hp	0.54	1.02	1.02	1.36	2.04	2.38	2.72
<b>Rated torque</b> <sup>1)</sup>	Nm	1.27	2.39	3.58	4.78	7.16	8.36	9.55
<b>Rated speed</b>	rpm	3000	3000	2000	2000	2000	2000	2000
<b>Maximum torque</b> <sup>1)</sup>	Nm	3.8	7.2	10.7	14.3	21.5	25.1	28.7
<b>Maximum speed</b>	rpm	4000	4000	3000	3000	3000	3000	3000
<b>Rated current</b>	A	1.2	2.1	2.5	3.0	4.6	5.3	5.9
<b>Maximum current</b>	A	3.6	6.3	7.5	9.0	13.8	15.9	17.7
<b>Torque constant</b>	Nm/A	1.1	1.2	1.5	1.7	1.6	1.7	1.7
<b>Moment of inertia</b>								
• without brake	10 <sup>-4</sup> kgm <sup>2</sup>	2.7	5.2	8.0	11.7	15.3	22.6	29.9
• with brake	10 <sup>-4</sup> kgm <sup>2</sup>	3.2	5.7	9.1	13.5	16.4	23.7	31.0
<b>Recommended load to motor inertia ratio, max.</b>		10x	10x	5x	5x	5x	5x	5x
<b>Encoder types</b>		<ul style="list-style-type: none"> <li>• Incremental encoder TTL, 2500 S/R</li> <li>• Absolute encoder 20-bit single-turn + 12-bit multi-turn</li> </ul>						
<b>Weight</b> <sup>2)</sup>								
• without brake	kg	3.4	5.2	5.7	7.0	8.4	11.1	13.7
• with brake	kg	4.8	6.6	8.8	10.1	11.5	14.2	16.8
<b>Holding brake</b> <sup>3)</sup>								
<b>Holding torque</b>	Nm	3.5	3.5	12.0	12.0	12.0	12.0	12.0
<b>Rated voltage</b>	V DC	24 ±10 %	24 ±10 %	24 ±10 %	24 ±10 %	24 ±10 %	24 ±10 %	24 ±10 %
<b>Opening time</b>	ms	60	60	180	180	180	180	180
<b>Closing time</b>	ms	45	45	60	60	60	60	60
<b>Rated current</b>	A	0.9	0.9	1.5	1.5	1.5	1.5	1.5

<sup>1)</sup> Rated torque, rated power and maximum torque listed in the table above allow for a production tolerance of 10 %.

<sup>2)</sup> Motor weight with incremental encoder.

<sup>3)</sup> It is not permissible to use the holding brake for an emergency stop.

## Technical specifications (continued)

		SIMOTICS S-1FL6 High Inertia			
		1FL6090-1AC...	1FL6092-1AC...	1FL6094-1AC...	1FL6096-1AC... <sup>4)</sup>
<b>Shaft height</b>		90			
<b>Rated power</b> <sup>1)</sup>	kW	2.5	3.5	5	7
	hp	3.40	4.76	6.80	9.52
<b>Rated torque</b> <sup>1)</sup>	Nm	11.90	16.70	23.90	33.40
<b>Rated speed</b>	rpm	2000	2000	2000	2000
<b>Maximum torque</b> <sup>1)</sup>	Nm	35.7	50.0	70.0	90.0
<b>Maximum speed</b>	rpm	3000	3000	2500	2000
<b>Rated current</b>	A	7.8	11.0	12.6	13.2
<b>Maximum current</b>	A	23.4	33.0	36.9	35.6
<b>Torque constant</b>	Nm/A	1.6	1.6	2.0	2.7
<b>Moment of inertia</b>					
• without brake	10 <sup>-4</sup> kgm <sup>2</sup>	47.4	69.1	90.8	134.3
• with brake	10 <sup>-4</sup> kgm <sup>2</sup>	56.3	77.9	99.7	143.2
<b>Recommended load to motor inertia ratio, max.</b>		5x			
<b>Encoder types</b>		<ul style="list-style-type: none"> <li>• Incremental encoder TTL, 2500 S/R</li> <li>• Absolute encoder 20-bit single-turn + 12-bit multi-turn</li> </ul>			
<b>Weight</b> <sup>2)</sup>					
• without brake	kg	15.4	19.8	24.4	33.3
• with brake	kg	21.5	25.9	30.5	39.3
<b>Holding brake</b> <sup>3)</sup>					
<b>Holding torque</b>	Nm	30.0			
<b>Rated voltage</b>	V DC	24 ± 10 %			
<b>Opening time</b>	ms	220			
<b>Closing time</b>	ms	115			
<b>Rated current</b>	A	1.9			

<sup>1)</sup> Rated torque, rated power and maximum torque listed in the table above allow for a production tolerance of 10 %.

<sup>2)</sup> Motor weight with incremental encoder.

<sup>3)</sup> It is not permissible to use the holding brake for an emergency stop.

<sup>4)</sup> For SIMOTICS S-1FL6096-... servomotors with brake, when the ambient temperature exceeds 30 °C (86 °F), the power should be derated by 10 %. Power derating is not required for other motors.



# SIMOTICS S-1FL6 servomotors

## SIMOTICS S-1FL6 servomotors for SINAMICS V90

### Characteristic curves

#### Torque-speed characteristic for SIMOTICS S-1FL6 Low Inertia when connected to SINAMICS V90

3

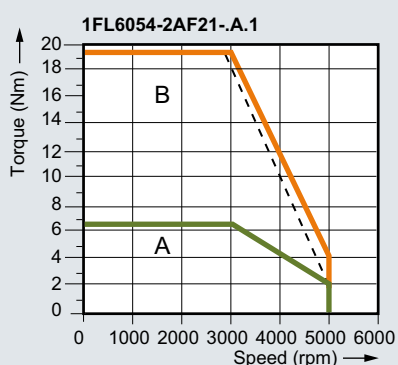
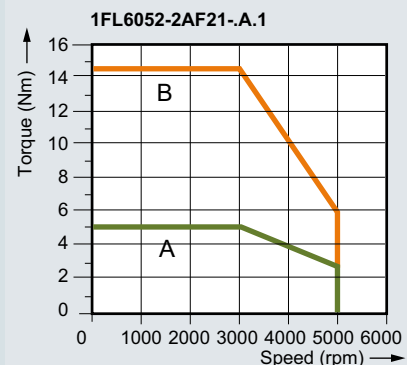
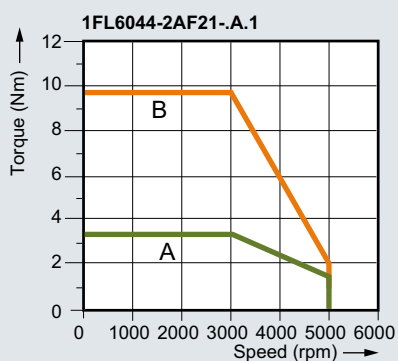
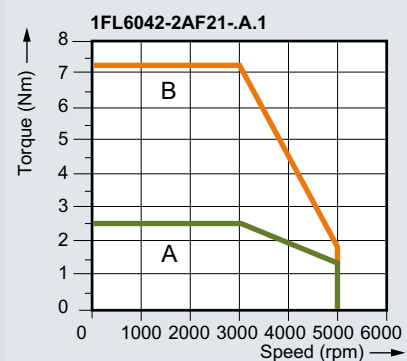
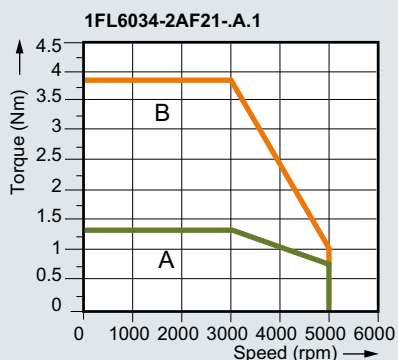
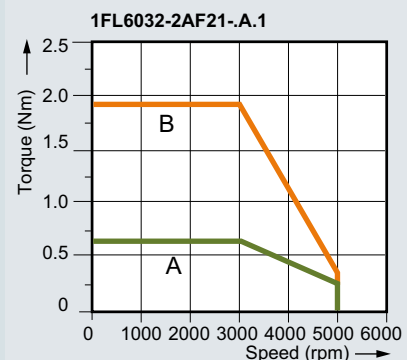
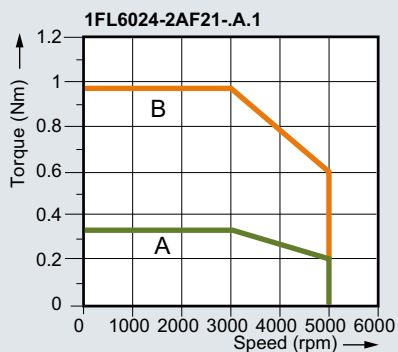
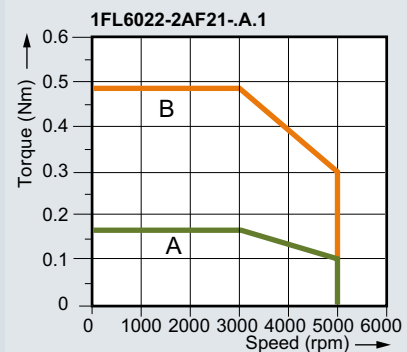

220 V AC supply voltage  
 A: Continuous operating area  
 B: Short-term operating area

— Supply voltage 220 V  
 - - - Supply voltage 198 V

G\_D011\_EN\_00483

Characteristic curves (continued)

Torque-speed characteristic for SIMOTICS S-1FL6 High Inertia when connected to SINAMICS V90

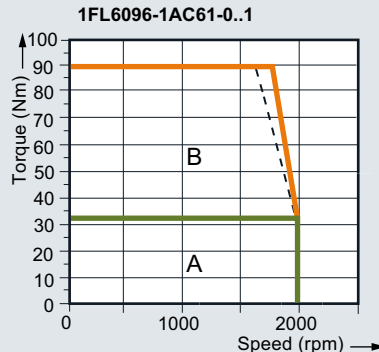
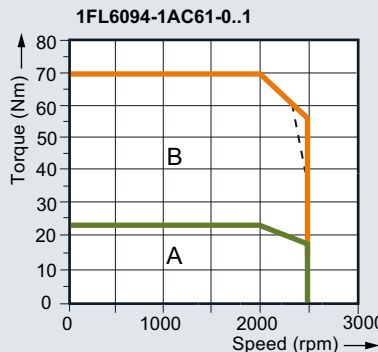
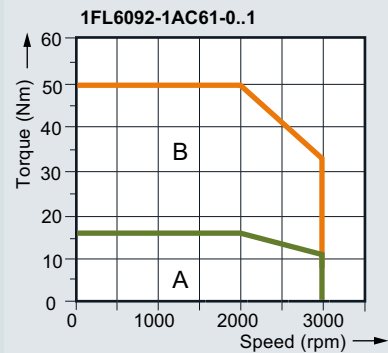
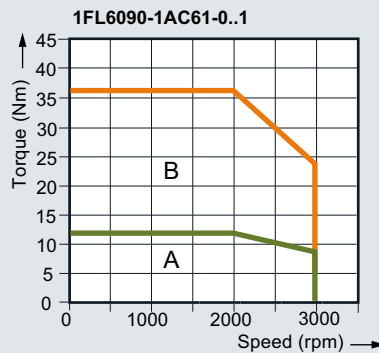
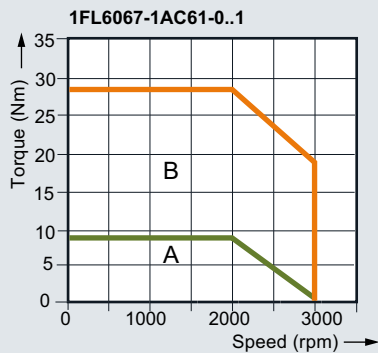
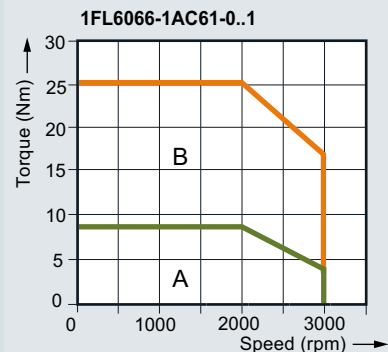
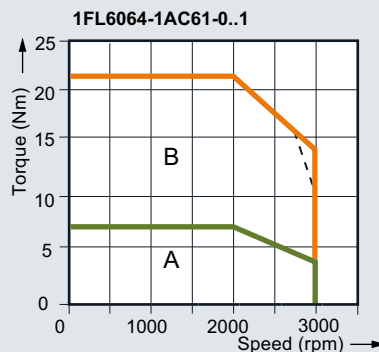
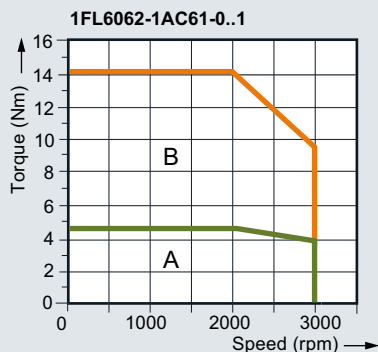
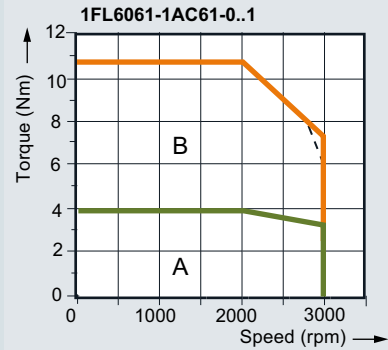
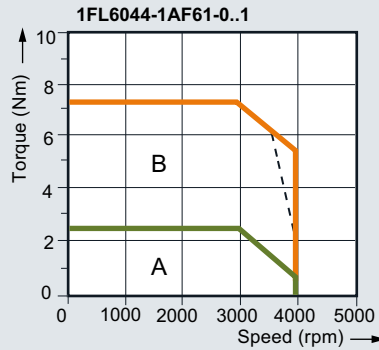
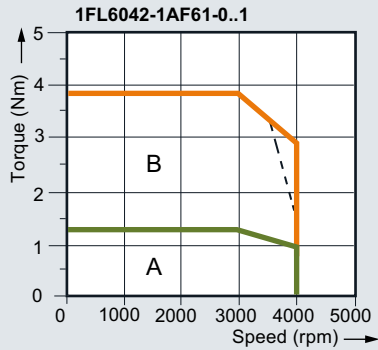

G\_D011\_EN\_00414

Notes:

A: Continuous operating area

B: Short-term operating area

— Supply voltage 400 V

- - - Supply voltage 380 V

# SIMOTICS S-1FL6 servomotors

## SIMOTICS S-1FL6 servomotors for SINAMICS V90

### Dimensional drawings

#### SIMOTICS S-1FL6 Low Inertia

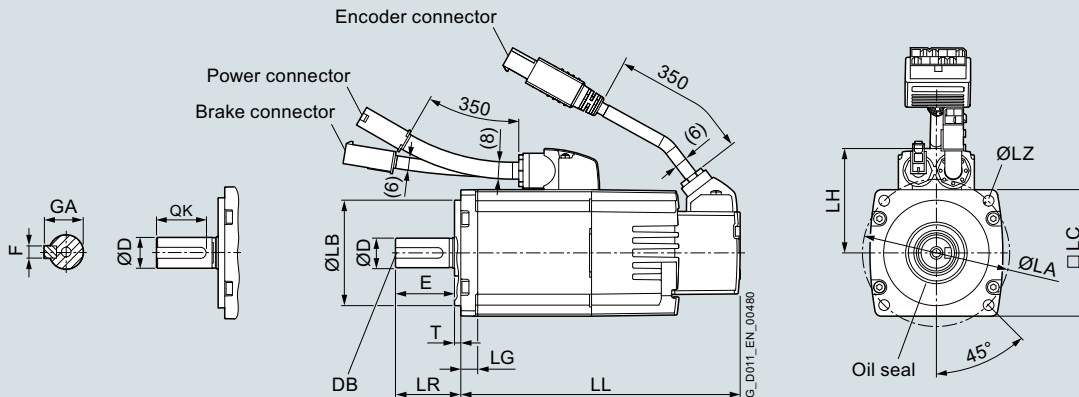

SIMOTICS S-1FL6 Low Inertia servomotors, shaft heights 20, 30, 40

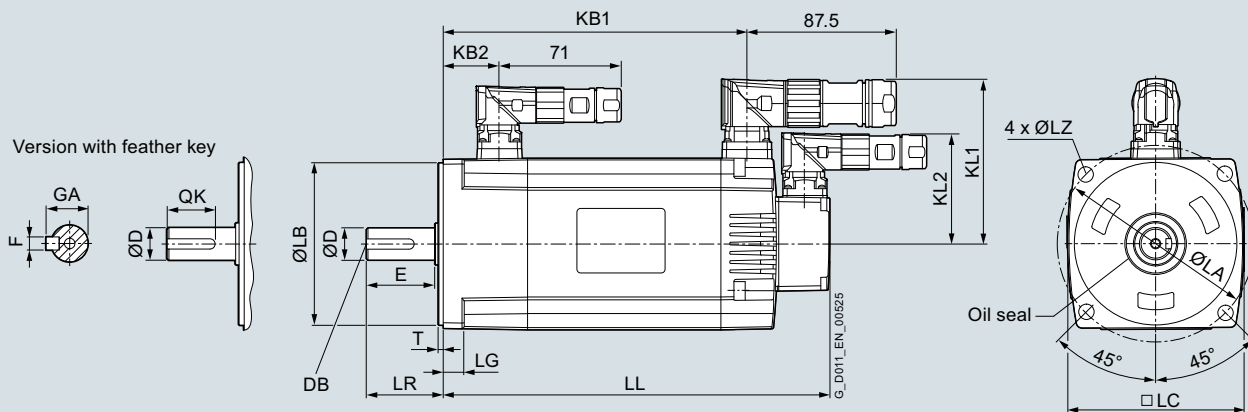

SIMOTICS S-1FL6 Low Inertia servomotor, shaft height 50

For motor		Dimensions in mm																				
Shaft height	Type	LC	LA	LZ	LB	LH	LR	T	LG	DE shaft extension					Without brake		With brake					
										D	DB	E	QK	GA	F	LL	KB1	LL	KB1	KB2	KL1	KL2
<b>SIMOTICS S-1FL6 Low Inertia, natural cooling, without/with brake</b>																						
20	1FL6022-2AF	40	46	4.5	30	40	25	2.5	6	8	M3×8	22	17.5	9	3	86	–	119	–	–	–	
	1FL6024-2AF	40	46	4.5	30	40	25	2.5	6	8	M3×8	22	17.5	9	3	106	–	139	–	–	–	
30	1FL6032-2AF	60	70	5.5	50	50	31	3	8	14	M4×15	26	22.5	16	5	98	–	132.5	–	–	–	
	1FL6034-2AF	60	70	5.5	50	50	31	3	8	14	M4×15	26	22.5	16	5	123	–	157.5	–	–	–	
40	1FL6042-2AF	80	90	7	70	60	35	3	8	19	M6×16	30	28	21.5	6	139	–	178.3	–	–	–	
	1FL6044-2AF	80	90	7	70	60	35	3	8	19	M6×16	30	28	21.5	6	158.8	–	198.1	–	–	–	
50	1FL6052-2AF	100	115	9	95	–	45	3	12	19	M6×16	40	28	21.5	6	192	143.5	226	177.5	32.5	98	65.5
	1FL6054-2AF	100	115	9	95	–	45	3	12	19	M6×16	40	28	21.5	6	216	167.5	250	201.5	32.5	98	65.5

**Dimensional drawings** (continued)

**SIMOTICS S-1FL6 High Inertia with incremental encoder**

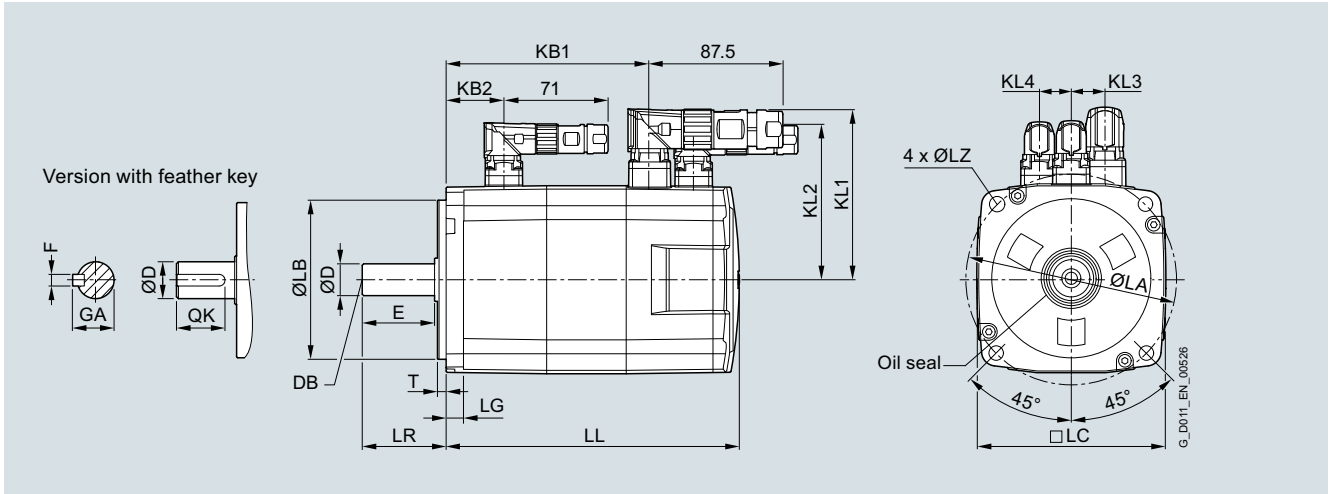

SIMOTICS S-1FL6 High Inertia servomotors, with incremental encoder

For motor		Dimensions in mm														Encoder system: Incremental encoder 2500 S/R								
Shaft height	Type	LC	LA	LZ	LB	LR	T	LG	D	DB	E	QK	GA	F	without brake		with brake		KL1	KL2	KL3	KL4		
															LL	KB1	KB2	LL					KB1	KB2
<b>SIMOTICS S-1FL6 High Inertia, natural cooling, without/with brake</b>																								
45	1FL6042	90	100	7	80	35	4	10	19	M6×16	30	25	21.5	6	154.5	93.5	-	201	140	31.5	96.2	84.6	13	14
	1FL6044	90	100	7	80	35	4	10	19	M6×16	30	25	21.5	6	201.5	140.5	-	248	187	31.5	96.2	84.6	13	14
65	1FL6061	130	145	9	110	58	6	12	22	M8×16	50	44	25	8	148	85.5	-	202.5	140	39.5	118	108	23	22
	1FL6062	130	145	9	110	58	6	12	22	M8×16	50	44	25	8	164	101.5	-	219	156.5	39.5	118	108	23	22
	1FL6064	130	145	9	110	58	6	12	22	M8×16	50	44	25	8	181	118.5	-	235.5	173	39.5	118	108	23	22
	1FL6066	130	145	9	110	58	6	12	22	M8×16	50	44	25	8	214	151.5	-	268.5	206	39.5	118	108	23	22
90	1FL6067	130	145	9	110	58	6	12	22	M8×16	50	44	25	8	247	184.5	-	301.5	239	39.5	118	108	23	22
	1FL6090	180	200	13.5	114.3	80	3	18	35	M12×25	75	60	38	10	189.5	140	-	255	206	44.5	143	143	34	34
	1FL6092	180	200	13.5	114.3	80	3	18	35	M12×25	75	60	38	10	211.5	162	-	281	232	44.5	143	143	34	34
	1FL6094	180	200	13.5	114.3	80	3	18	35	M12×25	75	60	38	10	237.5	188	-	307	258	44.5	143	143	34	34
	1FL6096	180	200	13.5	114.3	80	3	18	35	M12×25	75	60	38	10	289.5	240	-	359	310	44.5	143	143	34	34

## SIMOTICS S-1FL6 servomotors

## SIMOTICS S-1FL6 servomotors for SINAMICS V90

## Dimensional drawings (continued)

## SIMOTICS S-1FL6 High Inertia with absolute encoder

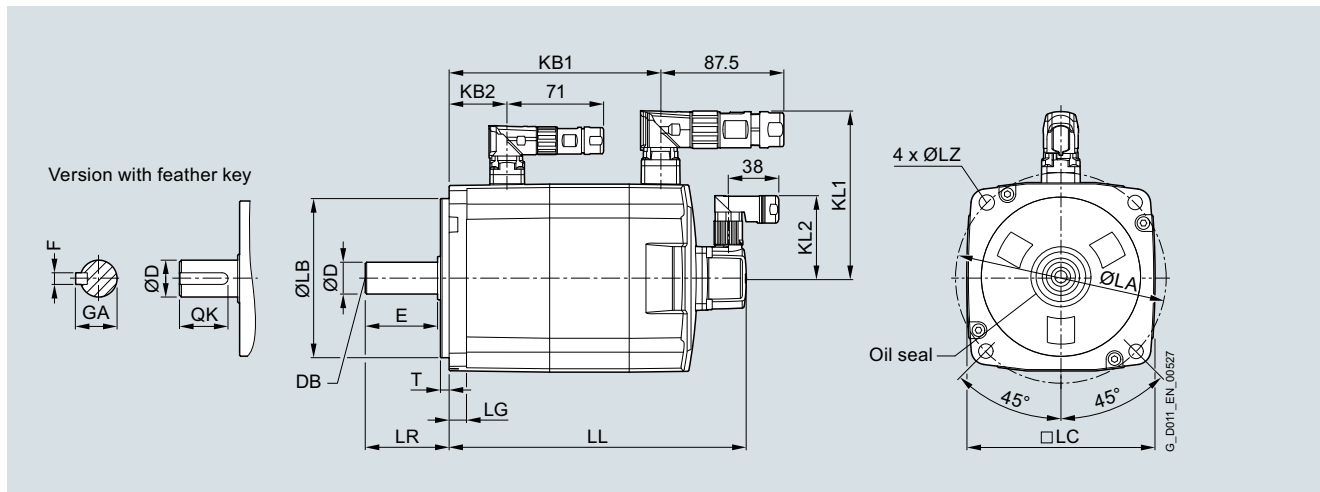

SIMOTICS S-1FL6 High Inertia servomotors, with absolute encoder

For motor		Dimensions in mm													Encoder system: Absolute encoder 20 bit							
Shaft height	Type	LC	LA	LZ	LB	LR	T	LG	DE shaft extension				without brake		with brake		KL1	KL2				
									D	DB	E	QK	GA	F	LL	KB1			KB2	LL	KB1	KB2
<b>SIMOTICS S-1FL6 High Inertia, natural cooling, without/with brake</b>																						
45	1FL6042	90	100	7	80	35	4	10	19	M6×16	30	25	21.5	6	157	100	–	203.5	146.5	31.5	96.2	60
	1FL6044	90	100	7	80	35	4	10	19	M6×16	30	25	21.5	6	204	147	–	250.5	193.5	31.5	96.2	60
65	1FL6061	130	145	9	110	58	6	12	22	M8×16	50	44	25	8	151	92	–	205.5	146.5	39.5	117.5	60
	1FL6062	130	145	9	110	58	6	12	22	M8×16	50	44	25	8	167.5	108.5	–	222	163	39.5	117.5	60
	1FL6064	130	145	9	110	58	6	12	22	M8×16	50	44	25	8	184	125	–	238.5	179.5	39.5	117.5	60
	1FL6066	130	145	9	110	58	6	12	22	M8×16	50	44	25	8	217	158	–	271.5	212.5	39.5	117.5	60
90	1FL6067	130	145	9	110	58	6	12	22	M8×16	50	44	25	8	250	191	–	304.5	245.5	39.5	117.5	60
	1FL6090	180	200	13.5	114.3	80	3	18	35	M12×25	75	60	38	10	197	135	–	263	201	45	143	60
	1FL6092	180	200	13.5	114.3	80	3	18	35	M12×25	75	60	38	10	223	161	–	289	227	45	143	60
	1FL6094	180	200	13.5	114.3	80	3	18	35	M12×25	75	60	38	10	249	187	–	315	253	45	143	60
	1FL6096	180	200	13.5	114.3	80	3	18	35	M12×25	75	60	38	10	301	239	–	367	305	45	143	60

Further information is available in the Drive Technology Configurator (DT Configurator) which can be used on the Internet.

The DT Configurator can be found in the Siemens Industry Mall at the following address:

[www.siemens.com/dt-configurator](http://www.siemens.com/dt-configurator)

## MOTION-CONNECT connection systems



<b>4/2</b>	<b>MOTION-CONNECT 300</b>
4/2	Overview
<b>4/3</b>	<b>Pre-assembled power cables for SINAMICS V90</b>
4/3	Overview
4/3	Technical specifications
<b>4/4</b>	<b>Pre-assembled signal cables for SINAMICS V90</b>
4/4	Overview
4/4	Technical specifications
<b>4/6</b>	<b>Connectors for SINAMICS V90</b>
4/6	Overview

For **selection and ordering data** please refer to section "System overview" "SINAMICS V90 basic servo drive system" from page 1/10.

Detailed technical information on SINAMICS V90 is available on the Internet at:  
[www.siemens.com/sinamics-v90/documentation](http://www.siemens.com/sinamics-v90/documentation)

In addition, the Drive Technology Configurator (DT Configurator) can be used on the Internet at the following address:  
[www.siemens.com/dt-configurator](http://www.siemens.com/dt-configurator)



## MOTION-CONNECT connection systems

### MOTION-CONNECT 300

#### Overview

The use of pre-assembled MOTION-CONNECT 300 cables ensures high quality and system-tested, problem-free operation.

Degree of protection of pre-assembled power and signal cables and their extensions is IP65 when closed and connected unless otherwise stated.

MOTION-CONNECT 300 cables are not suitable for outdoor use.

MOTION-CONNECT 300 cables are approved for a maximum horizontal travel distance of 5 m without support.

The cables must be unwound without twisting.

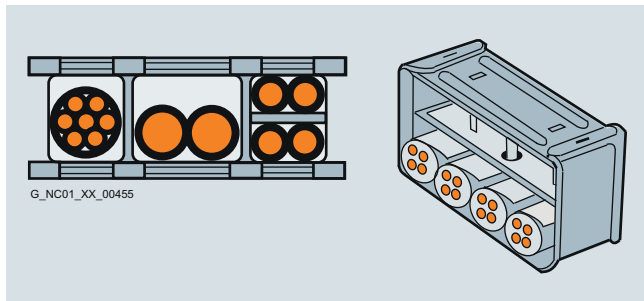

To maximize the service life of the cable carrier and cables, cables in the carrier made from different materials must be separated in the cable carrier using spacers. The spacers must be filled evenly to ensure that the position of the cables does not change during operation. The cables should be distributed as symmetrically as possible according to their weights and dimensions. Cables with different outer diameters should be separated by spacers as well.

When inserting pre-assembled cables into the cable carrier, do not pull at the connector, as this may damage the strain relief or cable clamping.

The cables must not be fixed in the cable carrier. They must be freely movable.

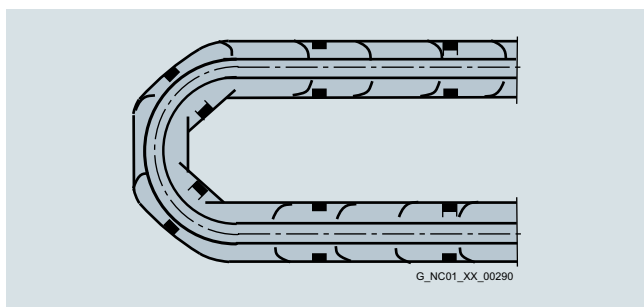

The cables must be able to be moved without applying force, specifically in the bending radii of the carrier. The specified minimum bending radii must be adhered to.

The cable fixings must be attached at both ends at an appropriate distance from the end points of the moving parts in a dead zone.

Cables must be installed in accordance with the instructions supplied by the cable carrier manufacturer.

In case of vibration load and with horizontal or vertical cable entries, we recommend that the cable is additionally fixed if between the cable strain relief on the cable carrier and the terminal at the motor part of the cable is hanging loose or is not routed. To prevent machine vibrations being transmitted to the connectors, the cable should be fixed at the moving part where the motor is mounted.

#### Derating factors for power and signal cables

Ambient air temperature °C (°F)	Derating factor according to EN 60204-1 Table D.1
30 (86)	1.15
35 (95)	1.08
40 (104)	1.00
45 (113)	0.91
50 (122)	0.82
55 (131)	0.71
60 (140)	0.58

## Overview



Example: MOTION-CONNECT 300, power cable for SIMOTICS S-1FL6 Low Inertia servomotors



Example: MOTION-CONNECT 300, power cable for SIMOTICS S-1FL6 High Inertia servomotors

For selection and ordering data please refer to section "System overview" "SINAMICS V90 basic servo drive system" from page 1/10.

## Technical specifications

Product name	<b>MOTION-CONNECT 300 power cable</b> SINAMICS V90 200 ... 240 V 1 AC/3 AC – SIMOTICS S-1FL6 Low Inertia, 0.05 kW ... 1 kW	SINAMICS V90 200 ... 240 V 1 AC/3 AC – SIMOTICS S-1FL6 Low Inertia, 1.5 kW ... 2 kW SINAMICS V90 380 ... 480 V 3 AC – SIMOTICS S-1FL6 High Inertia, 0.4 kW ... 7 kW
Type	6FX3002-5CK01-....	6FX3002-5CL02-.... 6FX3002-5CL12-.... 6FX3002-5CK32-....
<b>No. of cores</b>	4	4
<b>Degree of protection</b> motor side (when closed and connected)	IP20	IP65
<b>Certificate of suitability</b>		
• RoHS	Yes	Yes
• UL	cURus	No UL for motor side connector
• CE	Yes	Yes
<b>Rated voltage <math>U_0/U</math></b>	300 V/500 V	600 V/1000 V
<b>Test voltage, rms</b>	4 kV	4 kV
<b>Operating temperature on the surface</b>		
• Fixed installation	-25 ... +80 °C	-25 ... +80 °C
<b>Tensile stress, max.</b>		
• Fixed installation	50 N/mm <sup>2</sup>	50 N/mm <sup>2</sup>
• Flexible installation	20 N/mm <sup>2</sup>	20 N/mm <sup>2</sup>
<b>Smallest bending radius</b>		
• Fixed installation	6 × diameter	6 × diameter
• Flexible installation	155 mm	155 mm
<b>Torsional stress</b>	Absolute 30°/m	Absolute 30°/m
<b>Bending</b>	100000	1000000
<b>Insulation material, incl. jacket</b>	PVC	PVC
<b>Oil resistance</b>	EN 60811-2-1	EN 60811-2-1
<b>Outer jacket</b>	PVC	PVC
<b>Flame-retardant</b>	EN 60332-1-1 to 1-3	EN 60332-1-1 to 1-3

## MOTION-CONNECT connection systems

### Pre-assembled signal cables for SINAMICS V90

#### Overview

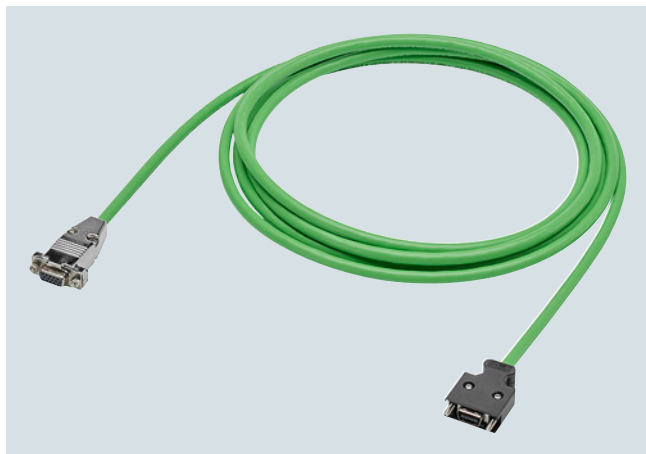

Example: MOTION-CONNECT 300, signal cable for encoder connection for SIMOTICS S-1FL6 Low Inertia servomotors



Example: MOTION-CONNECT 300, signal cable for encoder connection for SIMOTICS S-1FL6 High Inertia servomotors

For selection and ordering data please refer to section "System overview" "SINAMICS V90 basic servo drive system" from page 1/10.

#### Technical specifications

Product name	<b>MOTION-CONNECT 300 signal cable for encoder connection</b>	
	SINAMICS V90 200 ... 240 V 1 AC/3 AC – SIMOTICS S-1FL6 Low Inertia, 0.05 kW ... 1 kW	SINAMICS V90 200 ... 240 V 1 AC/3 AC – SIMOTICS S-1FL6 Low Inertia, 1.5 kW ... 2 kW SINAMICS V90 380 ... 480 V 3 AC – SIMOTICS S-1FL6 High Inertia, 0.4 kW ... 7 kW
Type	6FX3002-2DB20-.... 6FX3002-2CT20-....	6FX3002-2DB10-.... 6FX3002-2DB12-.... 6FX3002-2CT12-....
<b>No. of cores</b>	10	10
<b>Degree of protection</b> motor side (when closed and connected)	IP20	IP65
<b>Certificate of suitability</b>		
• RoHS	Yes	Yes
• UL	cURus	cURus (for 6FX3002-2CT12-.... no UL for motor side connector)
• CE	Not required	Not required
<b>Rated voltage <math>U_0/U</math></b>	30 V/30 V	30 V/30 V
<b>Test voltage, rms</b>	500 V	500 V
<b>Operating temperature on the surface</b>		
• Fixed installation	-25 ... +80 °C	-25 ... +80 °C
<b>Tensile stress, max.</b>		
• Fixed installation	50 N/mm <sup>2</sup>	50 N/mm <sup>2</sup>
• Flexible installation	20 N/mm <sup>2</sup>	20 N/mm <sup>2</sup>
<b>Smallest bending radius</b>		
• Fixed installation	6 × diameter	6 × diameter
• Flexible installation	155 mm	155 mm
<b>Torsional stress</b>	Absolute 30°/m	Absolute 30°/m
<b>Bending</b>	100000	100000
<b>Insulation material, incl. jacket</b>	PVC	PVC
<b>Oil resistance</b>	EN 60811-2-1	EN 60811-2-1
<b>Outer jacket</b>	PVC	PVC
<b>Flame-retardant</b>	EN 60332-1-1 to 1-3	EN 60332-1-1 to 1-3

## Overview (continued)



Example: MOTION-CONNECT 300, signal cable for brake connection for SIMOTICS S-1FL6 Low Inertia servomotors



Example: MOTION-CONNECT 300, signal cable for brake connection for SIMOTICS S-1FL6 High Inertia servomotors

For selection and ordering data please refer to section "System overview" "SINAMICS V90 basic servo drive system" from page 1/10.













## Technical specifications (continued)

Product name	<b>MOTION-CONNECT 300 signal cable for brake connection</b>	
	SINAMICS V90 200 ... 240 V 1 AC/3 AC – SIMOTICS S-1FL6 Low Inertia, 0.05 kW ... 1 kW	SINAMICS V90 200 ... 240 V 1 AC/3 AC – SIMOTICS S-1FL6 Low Inertia, 1.5 kW ... 2 kW SINAMICS V90 380 ... 480 V 3 AC – SIMOTICS S-1FL6 High Inertia, 0.4 kW ... 7 kW
Type	6FX3002-5BK02-....	6FX3002-5BL03-....
<b>No. of cores</b>	2	2
<b>Degree of protection</b> motor side (when closed and connected)	IP20	IP65
<b>Certificate of suitability</b>		
• RoHS	Yes	Yes
• UL	cURus	No UL for motor side connector
• CE	Not required	Not required
<b>Rated voltage <math>U_0/U</math></b>	30 V/30 V	30 V/30 V
<b>Test voltage, rms</b>	500 V	500 V
<b>Operating temperature on the surface</b>		
• Fixed installation	-25 ... +80 °C	-25 ... +80 °C
<b>Tensile stress, max.</b>		
• Fixed installation	50 N/mm <sup>2</sup>	50 N/mm <sup>2</sup>
• Flexible installation	20 N/mm <sup>2</sup>	20 N/mm <sup>2</sup>
<b>Smallest bending radius</b>		
• Fixed installation	6 × diameter	6 × diameter
• Flexible installation	155 mm	155 mm
<b>Torsional stress</b>	Absolute 30°/m	Absolute 30°/m
<b>Bending</b>	100000	1000000
<b>Insulation material, incl. jacket</b>	PVC	PVC
<b>Oil resistance</b>	EN 60811-2-1	EN 60811-2-1
<b>Outer jacket</b>	PVC	PVC
<b>Flame-retardant</b>	EN 60332-1-1 to 1-3	EN 60332-1-1 to 1-3

# MOTION-CONNECT connection systems

## Connectors for SINAMICS V90

### Overview

Shaft height	Connectors motor side			
	for power connection	for incremental encoder	for absolute encoder	for brake
<b>MOTION-CONNECT connectors for SIMOTICS S-1FL6 Low Inertia servomotors</b>				
20, 30, 40	6FX2003-0LL12	6FX2003-0SL12	6FX2003-0DB12	6FX2003-0LL52
				
50	6FX2003-0LL13	6FX2003-0SL13	6FX2003-0DB13	6FX2003-0LL53
				
<b>MOTION-CONNECT connectors for SIMOTICS S-1FL6 High Inertia servomotors</b>				
45, 65, 90	6FX2003-0LL13	6FX2003-0SL13	6FX2003-0DB11	6FX2003-0LL53
				
Frame size	Connectors drive side			
	for power connection	for incremental encoder	for absolute encoder	for brake
<b>MOTION-CONNECT connectors for SINAMICS V90 servo drive</b>				
FSA, FSB, FSC, FSD	–	6FX2003-0SB14	6FX2003-0SB14	–
				

For selection and ordering data please refer to section "System overview" "SINAMICS V90 basic servo drive system" from page 1/10.



### Security information

Siemens provides products and solutions with industrial security functions that support the secure operation of plants, systems, machines and networks.

In order to protect plants, systems, machines and networks against cyber threats, it is necessary to implement – and continuously maintain – a holistic, state-of-the-art industrial security concept. Siemens' products and solutions constitute one element of such a concept.

Customers are responsible for preventing unauthorized access to its plants, systems, machines and networks. Such systems, machines and components should only be connected to an enterprise network or the internet if and to the extent such a connection is necessary and only when appropriate security measures (e.g. firewalls and/or network segmentation) are in place.

For additional information on industrial security measures that may be implemented, please visit

<https://www.siemens.com/industrialsecurity>

Siemens' products and solutions undergo continuous development to make them more secure. Siemens strongly recommends that product updates are applied as soon as they are available and that the latest product versions are used. Use of product versions that are no longer supported, and failure to apply latest updates may increase customer's exposure to cyber threats.

To stay informed about product updates, subscribe to the Siemens Industrial Security RSS Feed under

<https://www.siemens.com/industrialsecurity>

5/2

5/2

5/2

5/2

### Drive Technology Configurator

Overview

Selection and ordering data

More information

5/3

5/3

### SINAMICS V-ASSISTANT

Overview



## Engineering tools

### Drive Technology Configurator

#### Overview

The Drive Technology Configurator (DT Configurator) helps you to configure the optimum drive technology products for your application – starting with gear units, motors, converters as well as the associated options and components and ending with controllers, software licenses and connection systems. Whether with little or detailed knowledge of products: preselected product groups, deliberate navigation through selection menus and direct product selection through entry of the article number support quick, efficient and convenient configuration.

In addition, comprehensive documentation comprising technical data sheets, 2D dimensional drawings/3D CAD models, operating instructions, certificates, etc. can be selected in the DT Configurator. Immediate ordering is possible by simply transferring a parts list to the shopping cart of the Industry Mall.

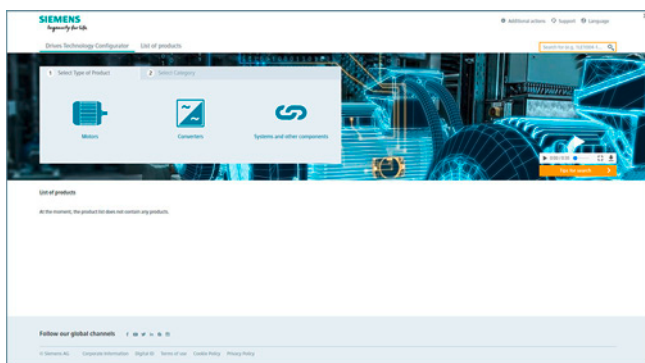

#### *Drive Technology Configurator for efficient drive configuration with the following functions*

- Quick and easy configuration of drive products and associated components – gear units, motors, converters, controllers, connection systems
- Configuration of drive systems for pumps, fans and compressor applications from 1 kW to 2.6 MW
- Retrievable documentation for configured products and components, such as
  - Data sheets in up to 9 languages in PDF or RTF format
  - 2D dimensional drawings/3D CAD models in various formats
  - Terminal box drawing and terminal connection diagram
  - Operating instructions
  - Certificates
  - Start-up calculation for SIMOTICS motors
  - EPLAN macros
- Support with retrofitting in conjunction with Spares On Web ([www.siemens.com/sow](http://www.siemens.com/sow))
- Ability to order products directly through the Siemens Industry Mall

#### Access to the Drive Technology Configurator

The Drive Technology Configurator can be called up without registration and without a login:  
[www.siemens.com/dt-configurator](http://www.siemens.com/dt-configurator)

#### More information

##### Online access to the Drive Technology Configurator

More information about the Drive Technology Configurator is available on the Internet at  
[www.siemens.com/dtconfigurator](http://www.siemens.com/dtconfigurator)

##### Offline access to the Drive Technology Configurator in the Interactive Catalog CA 01

In addition, the Drive Technology Configurator is also included in the Interactive Catalog CA 01 – the offline version of the Siemens Industry Mall.

The Interactive Catalog CA 01 in German, English, French and Spanish is available for downloading from the Internet:  
[www.siemens.com/automation/CA01](http://www.siemens.com/automation/CA01)

Overview

*SINAMICS V-ASSISTANT – Easy-to-use engineering tool for commissioning and diagnostics*

A PC with installed SINAMICS V-ASSISTANT software tool can be connected to SINAMICS V90 via a standard USB port. It is used for setting parameters, test operation, troubleshooting – and has powerful monitoring functions.

SINAMICS V-ASSISTANT can be downloaded free of charge from the SINAMICS V90 Internet page: [www.siemens.com/sinamics-v90](http://www.siemens.com/sinamics-v90)

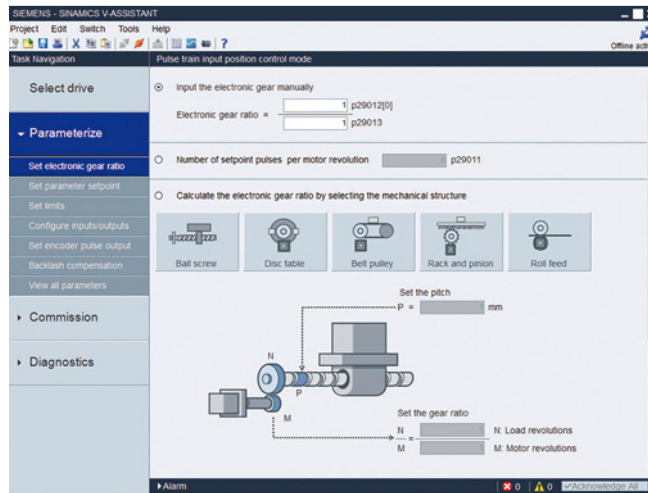

User task-centric design for prompted machine commissioning

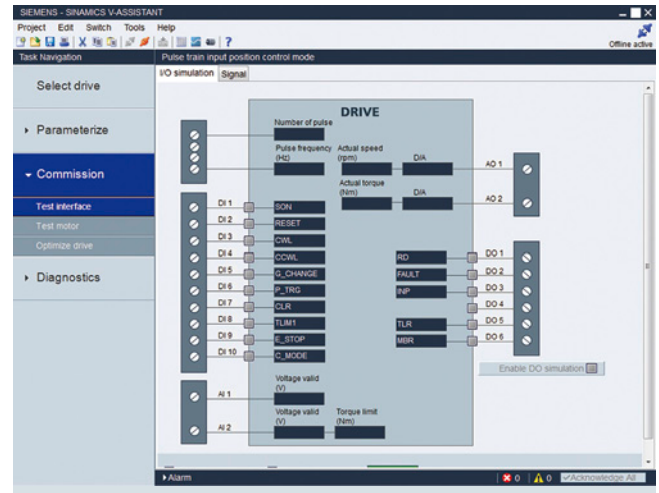

Graphic view to monitor the digital inputs/outputs and other control signals

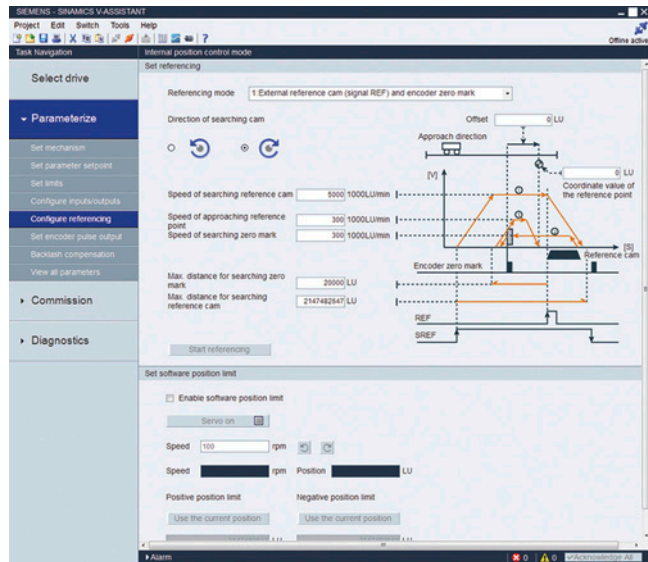

Graphic screen so that users can quickly and simply configure machines

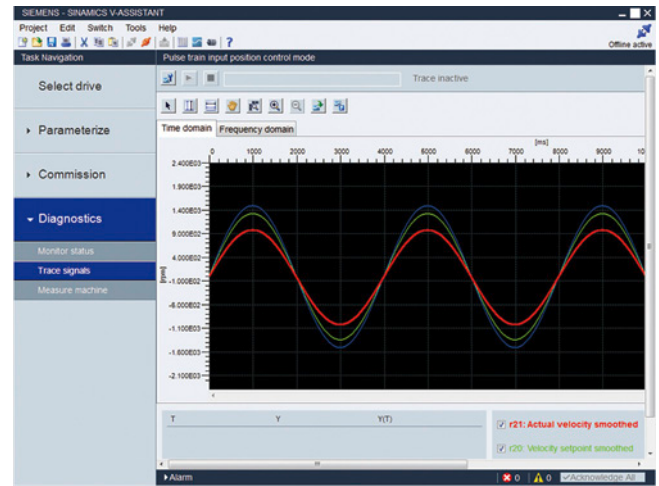

Trace function to monitor the drive and motor status

## Engineering tools

### Notes

5

## Services and documentation



<b>6/2</b>	<b>Partner at Siemens</b>
<b>6/3</b>	<b>Industry Services</b>
6/3	Overview
6/3	<a href="#">Industry Services – Portfolio overview</a>
6/4	Overview
6/6	<a href="#">Online Support</a>
6/6	Overview
<b>6/7</b>	<b>Training</b>
6/7	<a href="#">SITRAIN – Digital Industry Academy</a>
6/8	<a href="#">SINAMICS V90 training case</a>
6/8	Overview
6/8	Technical specifications
6/8	Selection and ordering data
<b>6/9</b>	<b>Applications</b>
6/9	Overview
<b>6/10</b>	<b>Documentation</b>
6/10	<a href="#">General documentation</a>
6/10	Overview
6/10	Application
6/10	Selection and ordering data

## Services and documentation

### Partner

#### Partner at Siemens

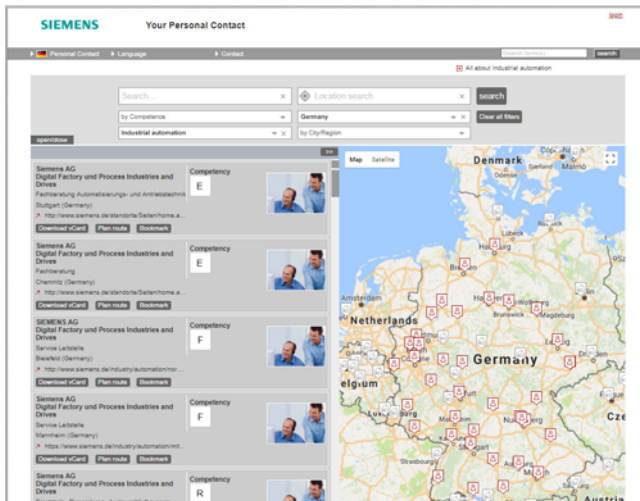

At your service locally, around the globe for consulting, sales, training, service, support, spare parts on the entire portfolio of Digital Industries.

Your partner can be found in our Personal Contacts Database at: [www.siemens.com/automation-contact](http://www.siemens.com/automation-contact)

You start by selecting

- the required competence,
- products and branches,
- a country and a city

or by a

- location search or free text search.

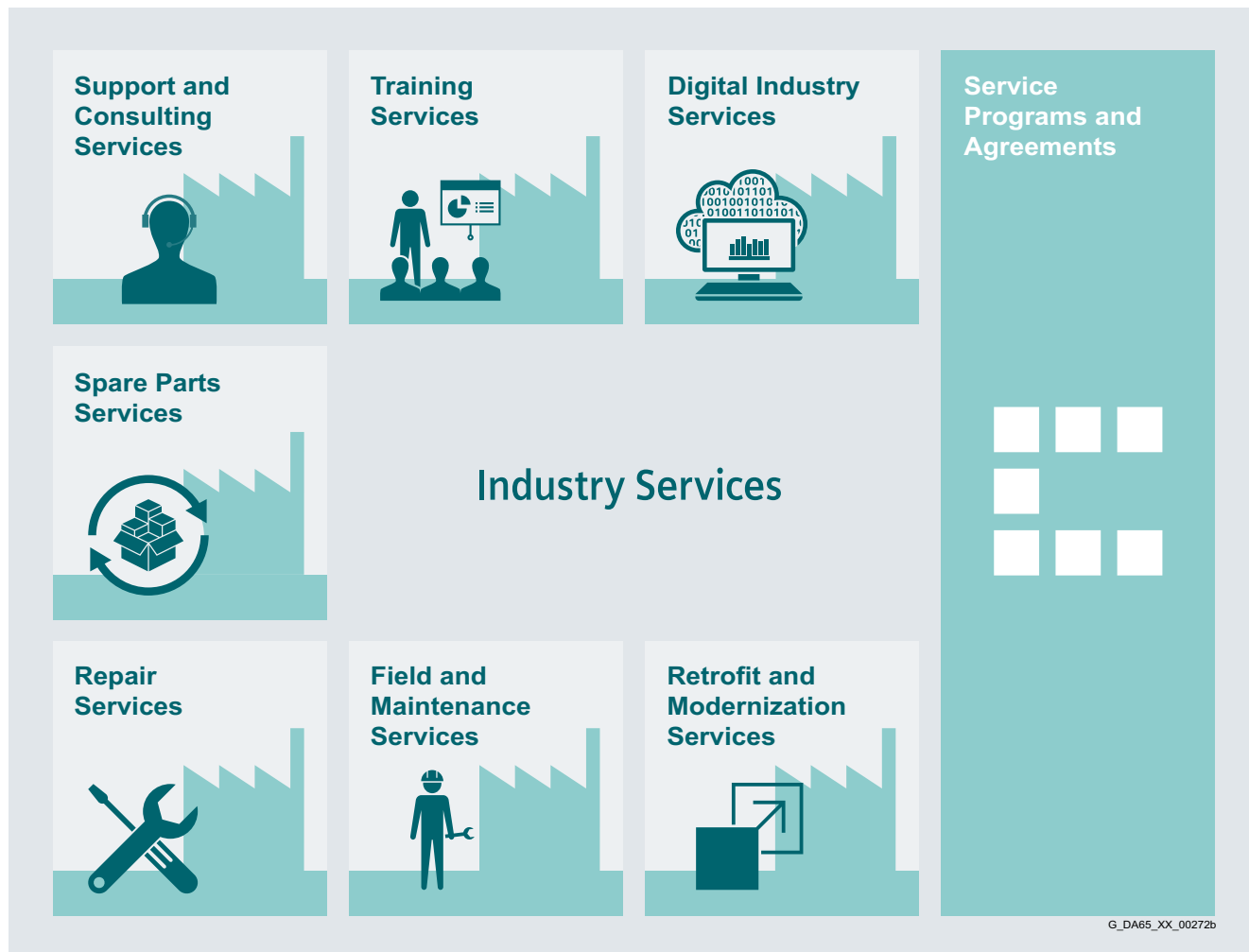
**Overview**

**Keep your business running and shaping your digital future – with Industry Services**

Optimizing the productivity of your equipment and operations can be a challenge, especially with constantly changing market conditions. Working with our service experts makes it easier. We understand your industry's unique processes and provide the services needed so that you can better achieve your business goals.

You can count on us to maximize your uptime and minimize your downtime, increasing your operations' productivity and reliability. When your operations have to be changed quickly to meet a new demand or business opportunity, our services give you the flexibility to adapt. Of course, we take care that your production is protected against cyber threats. We assist in keeping your operations as energy and resource efficient as possible and reducing your total cost of ownership. As a trendsetter, we ensure that you can capitalize on the opportunities of digitalization and by applying data analytics to enhance decision making: You can be sure that your plant reaches its full potential and retains this over the longer lifespan.

You can rely on our highly dedicated team of engineers, technicians and specialists to deliver the services you need – safely, professionally and in compliance with all regulations. We are there for you, where you need us, when you need us.

[www.siemens.com/industryservices](http://www.siemens.com/industryservices)

## Services and documentation

### Industry Services

#### Industry Services – Portfolio overview

##### Overview

#### Digital Industry Services



Digital Industry Services make your industrial processes transparent to gain improvements in productivity, asset availability, and energy efficiency.

Production data is generated, filtered and translated with intelligent analytics to enhance decision-making.

This is done whilst taking data security into consideration and with continuous protection against cyber-attack threats.

[www.siemens.com/global/en/home/products/services/industry/digital-services.html](http://www.siemens.com/global/en/home/products/services/industry/digital-services.html)

#### Support and Consulting Services



**Industry Online Support** site for comprehensive information, application examples, FAQs and support requests.

**Technical and Engineering Support** for advice and answers for all inquiries about functionality, handling, and fault clearance. The Service Card as prepaid support for value added services such as Priority Call Back or Extended Support offers the clear advantage of quick and easy purchasing.

**Information & Consulting Services**, e.g. SIMATIC System Audit; clarity about the state and service capability of your automation system or Lifecycle Information Services; transparency on the lifecycle of the products in your plants.

<https://support.industry.siemens.com/cs/ww/en/sc/2235>

#### Training Services



From the basics and advanced to specialist skills, SITRAIN courses provide expertise right from the manufacturer – and encompass the entire spectrum of Siemens products and systems for the industry.

Worldwide, SITRAIN courses are available wherever you need a training course in more than 170 locations in over 60 countries.

<https://support.industry.siemens.com/cs/ww/en/sc/2226>

#### Spare Parts Services



Spare Parts Services are available worldwide for smooth and fast supply of spare parts – and thus optimal plant availability. Genuine spare parts are available for up to ten years. Logistic experts take care of procurement, transport, custom clearance, storage and order management. Reliable logistics processes ensure that components reach their destination as needed.

Since not all spare parts can be kept in stock at all times, Siemens offers a preventive measure for spare parts provisioning on the customer's premises with optimized **Spare Parts Packages** for individual products, custom-assembled drive components and entire integrated drive trains – including risk consulting.

**Asset Optimization Services** help you design a strategy for parts supply where your investment and carrying costs are reduced and the risk of obsolescence is avoided.

<https://support.industry.siemens.com/cs/ww/en/sc/2110>



### Overview (continued)

#### Repair Services



Repair Services are offered on-site and in regional repair centers for fast restoration of faulty devices' functionality.

Also available are extended repair services, which include additional diagnostic and repair measures, as well as emergency services.

<https://support.industry.siemens.com/cs/ww/en/sc/2154>

#### Retrofit and Modernization Services



Provide a cost-effective solution for the expansion of entire plants, optimization of systems or upgrading existing products to the latest technology and software, e.g. migration services for automation systems.

Service experts support projects from planning through commissioning and, if desired over the entire extended lifespan, e.g. Retrofit for Integrated Drive Systems for an extended lifetime of your machines and plants.

<https://support.industry.siemens.com/cs/ww/en/sc/2286>

#### Field and Maintenance Services



Siemens specialists are available globally to provide expert field and maintenance services, including commissioning, functional testing, preventive maintenance and fault clearance. All services can be included in customized service agreements with defined reaction times or fixed maintenance intervals.

<https://support.industry.siemens.com/cs/ww/en/sc/2265>

#### Service Programs and Agreements



A technical Service Program or Agreement enables you to easily bundle a wide range of services into a single annual or multi-year agreement.

You pick the services you need to match your unique requirements or fill gaps in your organization's maintenance capabilities.

Programs and agreements can be customized as KPI-based and/or performance-based contracts.

<https://support.industry.siemens.com/cs/ww/en/sc/2275>

## Services and documentation

Industry Services

### Online Support

#### Overview

Online Support – fast, intuitive, whenever you want, wherever you need

**Web**

[support.industry.siemens.com](http://support.industry.siemens.com)

**App**

Scan the QR code for information on our Online Support app.

- FAQ / Application examples**  
Information about industrial products, programming and configuration as well as application examples
- Technical information**  
Videos, documentation, manuals, updates, product notes, compatibility tool, certificates, planning data such as dimensional drawings, product data, 3D models
- Forum**  
Exchange information and experience with other users and experts

## Online Support for Siemens Industry Products

Siemens Industry and Online Support with some 1.7 million visitors per month is one of the most popular web services provided by Siemens. It is the central access point for comprehensive technical know-how about products, systems and services for automation and drives applications as well as for process industries.

In connection with the challenges and opportunities related to digitalization you can look forward to continued support with innovative offerings.

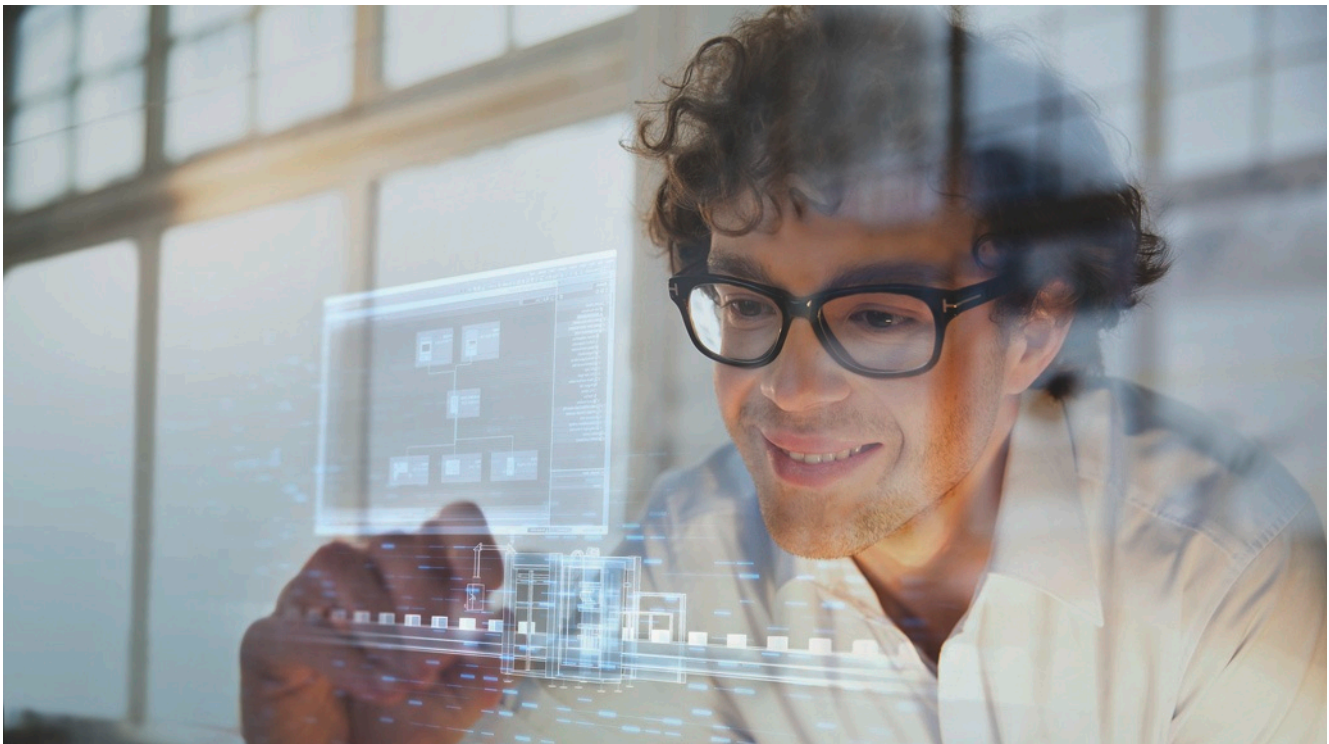

### Time for learning

Today's demands on our knowledge are every bit as diverse and dynamic as our profession itself. We keep learning more and longer – for our work, for our career and for ourselves. Advancing digitalization entails new topics and is also changing the way we absorb and process knowledge. SITRAIN – Digital Industry Academy offers the right source of knowledge here, which we can use anytime in just the way we need it. The time for learning is now.

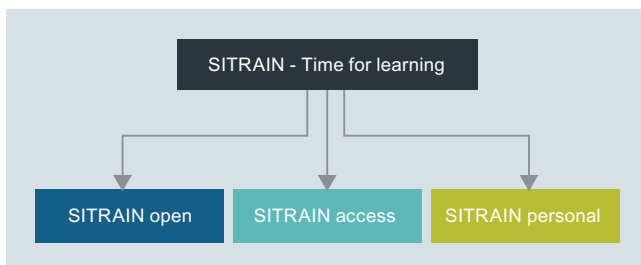

### Knowledge for every need

With its three areas – SITRAIN open, SITRAIN access and SITRAIN personal – SITRAIN offers you an all-encompassing range of options for an ongoing expansion of your knowledge and skills, suited for every type of learner. And SITRAIN uses advancing digitalization to continuously expand content and offer new training methods.

Find  
your local  
offer here



**SITRAIN – Digital Industry Academy**  
**Customer Support Germany**

Tel.: +49 911 895-7575

E-Mail: [sitrain.digital.industry.academy.de@siemens.com](mailto:sitrain.digital.industry.academy.de@siemens.com)

### Knowledge you can always find

SITRAIN open bundles useful information, worthwhile data and up-to-date expert knowledge about Siemens products for industry. Search it anytime, find anything – and always the right stuff.

### Knowledge that gets you ahead

SITRAIN access is learning in the digital age. It offers you individualized ways to build your knowledge and access to exclusive digital training courses. Take advantage of sustainable learning success with a wide range of learning methods. Improve your skills – whether working in groups with others, or by yourself. Whenever, wherever and however you need to.

### Knowledge you can experience

We all want to learn from the best. And SITRAIN personal's training courses let you benefit from our well-practiced trainers' expert knowledge, along with direct access to our training equipment. That's the best way to convey knowledge – whether at your company or in our training classrooms.

### **SITRAIN – Digital Industry Academy**

[www.siemens.com/sitrain](http://www.siemens.com/sitrain)

- SITRAIN open:  
[www.siemens.com/sitrain-open](http://www.siemens.com/sitrain-open)
- SITRAIN access:  
[www.siemens.com/sitrain-access](http://www.siemens.com/sitrain-access)
- SITRAIN personal:  
[www.siemens.com/sitrain-personal](http://www.siemens.com/sitrain-personal)

## Services and documentation

### Training

#### SINAMICS V90 training case

##### Overview



Example: SINAMICS V90 training case, pulse train version (PTI) without SIMATIC controller

The SINAMICS V90 training cases are convincing demonstration systems thanks to their compact design. They are suitable for direct customer presentations as well as for tests in technical departments. These training cases enable the functions of SINAMICS V90 to be demonstrated and tested quickly and easily.

The following training cases are available: 1-axis pulse train version (PTI) with and without SIMATIC controller and 2-axis PROFINET version (PN).

Depending on the version, the training cases contain the following components:

- SINAMICS V90 servo drive
- SIMOTICS S-1FL6 servomotor
- SIMATIC S7-1200 controller

The SINAMICS V90 training case is supplied in the form of a stackable Tanos Systainer case (size depending on training case version).

##### Technical specifications

SINAMICS V90 training case	6AG1067-2AA00-0AC0	6AG1067-3AA00-0AB0	6AG1067-1AA32-0AA0
<b>Supply voltage</b>	230 V 1 AC	230 V 1 AC	230 V 1 AC
<b>Version</b>	1-axis version Pulse train version (PTI) comprising <ul style="list-style-type: none"> <li>• SINAMICS V90 servo drive frame size FSA, 0.2 kW</li> <li>• SIMOTICS S-1FL6 Low Inertia servomotor</li> <li>• SIMATIC S7-1200 CPU1211C controller</li> </ul>	1-axis version Pulse train version (PTI) comprising <ul style="list-style-type: none"> <li>• SINAMICS V90 servo drive frame size FSAA, 0.4 kW</li> <li>• SIMOTICS S-1FL6 High Inertia servomotor</li> </ul>	2-axis version PROFINET version (PN) comprising <ul style="list-style-type: none"> <li>• 2 × SINAMICS V90 servo drive frame size FSAA, 0.2 kW</li> <li>• 2 × SIMOTICS S-1FL6 Low Inertia servomotor</li> </ul>
<b>Dimensions</b>			
• Width	400 mm (15.75 in)	400 mm (15.75 in)	340 mm (13.39 in)
• Height	315 mm (12.40 in)	315 mm (12.40 in)	470 mm (18.50 in)
• Depth	300 mm (11.81 in)	300 mm (11.81 in)	400 mm (15.75 in)
<b>Weight, approx.</b>	7.7 kg (17.0 lb)	12 kg (26.5 lb)	19.2 kg (42.3 lb)
<b>Delivery state</b>	Tanos Systainer size 3	Tanos Systainer size 4	Tanos Systainer size 4

##### Selection and ordering data

Description	Article No.
<b>SINAMICS V90 training case</b>	
• Pulse train version (PTI), 1-axis version with SIMATIC controller	<b>6AG1067-2AA00-0AC0</b>
• Pulse train version (PTI), 1-axis version without SIMATIC controller	<b>6AG1067-3AA00-0AB0</b>
• PROFINET version (PN), 2-axis version without SIMATIC controller	<b>6AG1067-1AA32-0AA0</b>



### Overview



Our understanding of an application is the customer-specific solution of an automation task based on standard hardware and software components. In this respect, industry knowledge and technological expertise are just as important as expert knowledge about how our products and systems work. We are setting ourselves this challenge with more than 280 application engineers in 20 countries.

#### Application centers

We currently have application centers in:

- Germany: Head Office in Erlangen and in other German regions, e.g. in Munich, Nuremberg, Stuttgart, Mannheim, Frankfurt, Chemnitz, Cologne, Bielefeld, Bremen, Hanover, Hamburg
- Belgium: Brussels
- Brazil: Sao Paulo
- China: Beijing and 12 regions
- Denmark: Ballerup
- France: Paris
- Great Britain: Manchester
- India: Mumbai
- Italy: Bologna, Milan
- Japan: Tokyo, Osaka
- The Netherlands: The Hague
- Austria: Vienna
- Poland: Warsaw
- Sweden: Göteborg
- Switzerland: Zurich, Lausanne
- Spain: Madrid
- South Korea: Seoul
- Taiwan: Taipeh
- Turkey: Istanbul
- USA: Atlanta

These application centers specialize in the use of SIMATIC/SIMOTION/SINAMICS. You therefore can rely on automation and drive specialists for implementing successful applications. By involving your personnel at an early stage in the process, we can provide a solid basis for rapid knowledge transfer, maintenance and further development of your automation solution.

#### Advice on applications and implementation

We offer a variety of consultation services to help you find the optimum solution for the SIMATIC/SIMOTION/SINAMICS application you want to implement:

The quotation phase includes

- clarification of technical questions,
- discussion of machine concepts and customer-specific solutions,
- selection of suitable technology and
- suggestions for implementation.

A technical feasibility study is also performed at the outset. In this way, difficult points of the application can be identified and solved early on. We can also configure and implement your application as a complete solution from a single source.

A large number of proven standard applications are available for use during the implementation phase. This saves engineering costs.

The system can be commissioned by experienced, competent personnel, if required. This saves time and trouble.

If servicing is required, we can support you on site or remotely. For further information about servicing, please see the section "Industry Services".

#### On-site application training

Training for the implemented applications can also be organized and carried out on site. This training for machine manufacturers and their customers does not deal with individual products, but the entire hardware and software system (for example, automation, drives and visualization).

From an initial concept to successful installation and commissioning: We provide complete support for SIMATIC/SIMOTION/SINAMICS! Contact your Siemens representative.

You can find further information at [www.siemens.com/machinebuilding](http://www.siemens.com/machinebuilding)

## Services and documentation

### Documentation

#### General documentation

##### Overview

A high-quality programmable control or drive system can be used to maximum effect only if the user is aware of the performance of the products used as a result of intensive training and good technical documentation.

This is becoming more important due to the shorter innovation cycles of modern automation products and the convergence of electronics and mechanical engineering.

A comprehensive range of documentation is available which includes a Getting Started guide, operating instructions, installation manuals and a list manual.

The documents are available in hardcopy form or as a PDF file for downloading from the Internet.

Information and documentation relating to SINUMERIK, SINAMICS, SIMOTION and SIMOTICS are available on the Internet at <https://support.industry.siemens.com/cs/document/109476679>

In addition to many other useful documents, the Information and Download Center also contains catalogs about the following systems:

- SINUMERIK: NC 62, NC 81.1, NC 82
- SINAMICS: D 11, D 12, D 21.3, D 21.4, D 23.1, D 23.2, D 31.1, D 31.2, D 31.5, D 32, D 33, D 35
- SIMOTION: PM 21
- SIMOTICS: D 21.4, D 41, D 81.1, D 81.8, D 83.1
- You can download these catalogs in PDF format – you don't need to log on. You can perform a targeted search using the filter box above the first displayed catalog. By entering the search term "NC 8", for example, you can locate Catalog NC 81.1 and Catalog NC 82, and by entering "ST 70" you will find Catalog ST 70 as well as the relevant news and add-ons (if available).  
[www.siemens.com/industry/infocenter](http://www.siemens.com/industry/infocenter)

##### Application

###### Explanations of the manuals:

- **Operating Instructions**  
contain all the information needed to install the device and make electrical connections, information about commissioning and a description of the converter functions.  
Phases of use: Control cabinet construction, commissioning, operation, maintenance and servicing.
- **Hardware Installation Manual**  
contains all relevant information about the intended use of the components of a system (technical specifications, interfaces, dimensional drawings, characteristics, or possible applications), information about installation and electrical connections and information about maintenance and servicing.  
Phases of use: Control cabinet configuration/construction, maintenance and servicing.
- **Operating and Installation Instructions**  
(for converter and accessories)  
contain all relevant information about the intended use of the components, such as technical specifications, interfaces, dimensional drawings, characteristics, or possible applications.  
Phases of use: Control cabinet configuration/construction.
- **Manual/Configuration Manual**  
contains all necessary information about the intended use of the components of a system, e.g. technical specifications, interfaces, dimensional drawings, characteristics, or possible applications.  
Phases of use: Cabinet configuration/setup, circuit diagram configuration/drawing.

- **Commissioning Manual**

contains all information relevant to commissioning after installation and wiring. It also contains all safety and warning notices relevant to commissioning in addition to overview drawings.

Phases of use: Commissioning of components that have already been connected, configuration of system functions.

- **List Manual**

contains all parameters, function diagrams, and faults/alarms for the product/system as well as their meanings and setting options. It contains parameter data and fault/alarm descriptions with functional correlations.

Phases of use: Commissioning of components that have already been connected, configuration of system functions, fault cause/diagnosis.

- **Getting Started**

provides information about getting started for the first-time user as well as references to additional information. It contains information about the basic steps to be taken during commissioning. The information in the other documentation should be carefully observed for all of the other work required.

Phases of use: Commissioning of components that have already been connected.

- **Function Manual Drive Functions**

contains all the relevant information about individual drive functions: Description, commissioning and integration in the drive system.

Phases of use: Commissioning of components that have already been connected, configuration of system functions.

##### Selection and ordering data

Description	Article No.
<b>Decentralization with PROFIBUS DP/DPV1</b>	Via bookstore
• German	<b>ISBN 978-3-89578-189-6</b>
• English	<b>ISBN 978-3-89578-218-3</b>
<b>Automating with PROFINET: Industrial Communication Based on Industrial Ethernet</b>	Via bookstore
• German	<b>ISBN 978-3-89578-293-0</b>
• English	<b>ISBN 978-3-89578-294-7</b>
<b>Configuration Manual EMC Installation Guideline SIMOCRANE, SIMOTICS, SIMOTION, SINAMICS, SINUMERIK</b>	
• German	<b>6FC5297-0AD30-0AP3</b>
• English	<b>6FC5297-0AD30-0BP3</b>
• Italian	<b>6FC5297-0AD30-0CP3</b>
• French	<b>6FC5297-0AD30-0DP3</b>
• Spanish	<b>6FC5297-0AD30-0EP3</b>
• Chinese Simplified	<b>6FC5297-0AD30-0RP3</b>

## Appendix



7/2	<b>Certificates of suitability</b>
7/4	<b>Software licenses</b>
7/6	<b>Conversion tables</b>
7/8	<b>Metal surcharges</b>
7/11	<b>Conditions of sale and delivery</b>



## Appendix

### Certificates of suitability







#### Overview

Many of the products in this Catalog fulfill requirements, e.g. for UL, CSA or FM and are labeled with the corresponding approval designation.

All of the certificates of suitability, approvals, certificates, declarations of conformity, test certificates, e.g. CE, UL, Safety Integrated etc. have been performed with the associated system components as they are described in the Catalogs and Configuration Manuals.

The certificates are only valid if the products are used with the described system components, are installed according to the Installation Guidelines and used for their intended purpose.

In other cases, the vendor of these products is responsible for arranging for the issue of new certificates.

Test code	Tested by	Device series/ Component	Test standard	Product category/ File-No.
<b>UL: Underwriters Laboratories</b> <i>Independent public testing body in North America</i>				
	UL according to UL standard	SINUMERIK	Standard UL 508, CSA C22.2 No. 142	NRAQ/7.E164110 NRAQ/7.E217227
		SIMOTION	Standard UL 508, CSA C22.2 No. 142	NRAQ/7.E164110
	UL according to CSA standard	SINAMICS	Standard UL 508, 508C, 61800-5-1 CSA C22.2 No. 142, 274	NRAQ/7.E164110, NMMS/2/7/8.E192450, NMMS/2/7/8.E203250, NMMS/7.E214113, NMMS/7.E253831
				NMMS/2/7/8.E121068 NMMS/7.E355661 NMMS/7.E323473
	UL according to UL and CSA standards	SIMODRIVE	Standard UL 508C, CSA C22.2 No. 274	NMMS/2/7/8.E192450 NMMS/7.E214113
	UL according to UL standard	SIMOTICS	Standard UL 1004-1, 1004-6, 1004-8, CSA C22.2 No. 100	PRGY2/8.E227215 PRHZ2/8.E93429 PRHJ2/8.E342747 PRGY2/8.E253922 PRHZ2/8.E342746
	UL according to CSA standard	Line/motor reactors	Standard UL 508, 506, 5085-1, 5085-2, 1561, CSA C22.2 No. 14, 47, 66.1-06, 66.2-06	XQNX2/8.E257859 NMTR2/8.E219022 NMMS2/8.E333628 XPTQ2/8.E257852 XPTQ2/8.E103521 NMMS2/8.E224872 XPTQ2/8.E354316 XPTQ2/8.E198309 XQNX2/8.E475972
	UL according to UL and CSA standards	Line filters, dv/dt filters, sine-wave filters	UL 1283, CSA C22.2 No. 8	FOKY2/8.E70122
		Resistors	UL 508, 508C, CSA C22.2 No. 14, 274	NMTR2/8.E224314 NMMS2/8.E192450 NMTR2/8.E221095 NMTR2/8.E226619
<b>TUV: TÜV Rheinland of North America Inc.</b> <i>Independent public testing body in North America, Nationally Recognized Testing Laboratory (NRTL)</i> <b>TÜV: TÜV SÜD Product Service</b> <i>Independent public testing body in Germany, Nationally Recognized Testing Laboratory (NRTL) for North America</i>				
	TUV according to UL and CSA standards	SINAMICS	NRTL listing according to standard UL 508C	U7V 12 06 20078 013 U7 11 04 20078 009 U7 11 04 20078 010 U7 11 04 20078 011
		SIMOTION	NRTL listing according to standard UL 508	U7V 13 03 20078 01
		SIMODRIVE	NRTL listing according to standard UL 508C, CSA C22.2. No. 14	CU 72090702
		Motion Control Encoder	NRTL listing according to UL 61010-1 CSA C22.2 No. 61010-1	U8V 10 06 20196 024

## Certificates of suitability

## Overview (continued)

Test code	Tested by	Device series/ Component	Test standard	Product category/ File-No.
<b>CSA: Canadian Standards Association</b> <i>Independent public testing body in Canada</i>				
	CSA according to CSA standard	SINUMERIK	Standard CSA C22.2 No. 142	2252-01 : LR 102527
<b>FMRC: Factory Mutual Research Corporation</b> <i>Independent public testing body in North America</i>				
	FM according to FM standard	SINUMERIK	Standard FMRC 3600, FMRC 3611, FMRC 3810, ANSI/ISA S82.02.1	–
<b>EAC: Ivanovo-Certificate</b> <i>Independent public testing body in the Russian Federation</i>				
	EAC in accordance with the EAC Directive	SINAMICS SINUMERIK SIMOTION	Standard IEC 61800-5-1/-2, IEC 61800-3	–
<b>RCM: Australian Communications and Media Authority</b> <i>Independent public testing body in Australia</i>				
	RCM according to EMC standard	SINAMICS SINUMERIK SIMOTION	Standard IEC AS 61800-3, EN 61800-3	–
<b>KC: National Radio Research Agency</b> <i>Independent public testing body in South Korea</i>				
	KC according to EMC standard	SINAMICS SINUMERIK SIMOTION	Standard KN 11	–
<b>BIA</b> <i>Federal Institute for Occupational Safety</i>				
–	Functional safety	SINAMICS SINUMERIK SIMOTION	Standard EN 61800-5-2	–
<b>TÜV SÜD Rail</b>				
–	Functional safety	SINAMICS SINUMERIK SIMOTION	Standard EN 61800-5-2	–

More information about certificates can be found online at:  
<https://support.industry.siemens.com/cs/ww/en/ps/cert>

## Appendix

### Software licenses

#### Overview

##### Software types

Software requiring a license is categorized into types. The following software types have been defined:

- Engineering software
- Runtime software

##### Engineering software

This includes all software products for creating (engineering) user software, e.g. for configuring, programming, parameterizing, testing, commissioning or servicing.

Data generated with engineering software and executable programs can be duplicated for your own use or for use by third-parties free-of-charge.

##### Runtime software

This includes all software products required for plant/machine operation, e.g. operating system, basic system, system expansions, drivers, etc.

The duplication of the runtime software and executable programs created with the runtime software for your own use or for use by third-parties is subject to a charge.

You can find information about license fees according to use in the ordering data (e.g. in the catalog). Examples of categories of use include per CPU, per installation, per channel, per instance, per axis, per control loop, per variable, etc.

Information about extended rights of use for parameterization/configuration tools supplied as integral components of the scope of delivery can be found in the readme file supplied with the relevant product(s).

##### License types

Siemens Industry Automation & Drive Technologies offers various types of software license:

- Floating license
- Single license
- Rental license
- Rental floating license
- Trial license
- Demo license
- Demo floating license

##### Floating license

The software may be installed for internal use on any number of devices by the licensee. Only the concurrent user is licensed. The concurrent user is the person using the program. Use begins when the software is started. A license is required for each concurrent user.

##### Single license

Unlike the floating license, a single license permits only one installation of the software per license.

The type of use licensed is specified in the ordering data and in the Certificate of License (CoL). Types of use include for example per instance, per axis, per channel, etc.

One single license is required for each type of use defined.

##### Rental license

A rental license supports the "sporadic use" of engineering software. Once the license key has been installed, the software can be used for a specific period of time (the operating hours do not have to be consecutive).

One license is required for each installation of the software.

##### Rental floating license

The rental floating license corresponds to the rental license, except that a license is not required for each installation of the software. Rather, one license is required per object (for example, user or device).

##### Trial license

A trial license supports "short-term use" of the software in a non-productive context, e.g. for testing and evaluation purposes. It can be transferred to another license.

##### Demo license

The demo license support the "sporadic use" of engineering software in a non-productive context, for example, use for testing and evaluation purposes. It can be transferred to another license. After the installation of the license key, the software can be operated for a specific period of time, whereby usage can be interrupted as often as required.

One license is required per installation of the software.

##### Demo floating license

The demo floating license corresponds to the demo license, except that a license is not required for each installation of the software. Rather, one license is required per object (for example, user or device).

##### Certificate of License (CoL)

The CoL is the licensee's proof that the use of the software has been licensed by Siemens. A CoL is required for every type of use and must be kept in a safe place.

##### Downgrading

The licensee is permitted to use the software or an earlier version/release of the software, provided that the licensee owns such a version/release and its use is technically feasible.

##### Delivery versions

Software is constantly being updated. The following delivery versions

- PowerPack
- Upgrade

can be used to access updates.

Existing bug fixes are supplied with the ServicePack version.

##### PowerPack

PowerPacks can be used to upgrade to more powerful software. The licensee receives a new license agreement and CoL (Certificate of License) with the PowerPack. This CoL, together with the CoL for the original product, proves that the new software is licensed.

A separate PowerPack must be purchased for each original license of the software to be replaced.

**Overview** (continued)**Upgrade**

An upgrade permits the use of a new version of the software on the condition that a license for a previous version of the product is already held.

The licensee receives a new license agreement and CoL with the upgrade. This CoL, together with the CoL for the previous product, proves that the new version is licensed.

A separate upgrade must be purchased for each original license of the software to be upgraded.

**ServicePack**

ServicePacks are used to debug existing products. ServicePacks may be duplicated for use as prescribed according to the number of existing original licenses.

**License key**

Siemens Industry Automation & Drive Technologies supplies software products with and without license keys.

The license key serves as an electronic license stamp and is also the "switch" for activating the software (floating license, rental license, etc.).

The complete installation of software products requiring license keys includes the program to be licensed (the software) and the license key (which represents the license).

**Software Update Service (SUS)**

As part of the SUS contract, all software updates for the respective product are made available to you free of charge for a period of one year from the invoice date. The contract will automatically be extended for one year if it is not canceled three months before it expires.

The possession of the current version of the respective software is a basic condition for entering into an SUS contract.

You can download explanations concerning license conditions from [www.siemens.com/automation/salesmaterial-as/catalog/en/terms\\_of\\_trade\\_en.pdf](http://www.siemens.com/automation/salesmaterial-as/catalog/en/terms_of_trade_en.pdf)

## Appendix

### Conversion tables

#### Rotary inertia (to convert from A to B, multiply by entry in table)

A \ B	lb-in <sup>2</sup>	lb-ft <sup>2</sup>	lb-in-s <sup>2</sup>	lb-ft-s <sup>2</sup> slug-ft <sup>2</sup>	kg-cm <sup>2</sup>	kg-cm-s <sup>2</sup>	gm-cm <sup>2</sup>	gm-cm-s <sup>2</sup>	oz-in <sup>2</sup>	oz-in-s <sup>2</sup>
lb-in <sup>2</sup>	1	$6.94 \times 10^{-3}$	$2.59 \times 10^{-3}$	$2.15 \times 10^{-4}$	2.926	$2.98 \times 10^{-3}$	$2.92 \times 10^3$	2.984	16	$4.14 \times 10^{-2}$
lb-ft <sup>2</sup>	144	1	0.3729	$3.10 \times 10^{-2}$	421.40	0.4297	$4.21 \times 10^5$	429.71	2304	5.967
lb-in-s <sup>2</sup>	386.08	2.681	1	$8.33 \times 10^{-2}$	$1.129 \times 10^3$	1.152	$1.129 \times 10^6$	$1.152 \times 10^3$	$6.177 \times 10^3$	16
lb-ft-s <sup>2</sup> slug-ft <sup>2</sup>	$4.63 \times 10^3$	32.17	12	1	$1.35 \times 10^4$	13.825	$1.355 \times 10^7$	$1.38 \times 10^4$	$7.41 \times 10^4$	192
kg-cm <sup>2</sup>	0.3417	$2.37 \times 10^{-3}$	$8.85 \times 10^{-4}$	$7.37 \times 10^{-5}$	1	$1.019 \times 10^{-3}$	1000	1.019	5.46	$1.41 \times 10^{-2}$
kg-cm-s <sup>2</sup>	335.1	2.327	0.8679	$7.23 \times 10^{-2}$	980.66	1	$9.8 \times 10^5$	1000	$5.36 \times 10^3$	13.887
gm-cm <sup>2</sup>	$3.417 \times 10^{-4}$	$2.37 \times 10^{-6}$	$8.85 \times 10^{-7}$	$7.37 \times 10^{-8}$	$1 \times 10^{-3}$	$1.01 \times 10^{-6}$	1	$1.01 \times 10^{-3}$	$5.46 \times 10^{-3}$	$1.41 \times 10^{-5}$
gm-cm-s <sup>2</sup>	0.335	$2.32 \times 10^{-3}$	$8.67 \times 10^{-4}$	$7.23 \times 10^{-5}$	0.9806	$1 \times 10^{-3}$	980.6	1	5.36	$1.38 \times 10^{-2}$
oz-in <sup>2</sup>	0.0625	$4.34 \times 10^{-4}$	$1.61 \times 10^{-4}$	$1.34 \times 10^{-5}$	0.182	$1.86 \times 10^{-4}$	182.9	0.186	1	$2.59 \times 10^{-3}$
oz-in-s <sup>2</sup>	24.13	0.1675	$6.25 \times 10^{-2}$	$5.20 \times 10^{-3}$	70.615	$7.20 \times 10^{-2}$	$7.09 \times 10^4$	72.0	386.08	1

#### Torque (to convert from A to B, multiply by entry in table)

A \ B	lb-in	lb-ft	oz-in	N-m	kg-cm	kg-m	gm-cm	dyne-cm
lb-in	1	$8.333 \times 10^{-2}$	16	0.113	1.152	$1.152 \times 10^{-2}$	$1.152 \times 10^3$	$1.129 \times 10^6$
lb-ft	12	1	192	1.355	13.825	0.138	$1.382 \times 10^4$	$1.355 \times 10^7$
oz-in	$6.25 \times 10^{-2}$	$5.208 \times 10^{-3}$	1	$7.061 \times 10^{-3}$	$7.200 \times 10^{-2}$	$7.200 \times 10^{-4}$	72.007	$7.061 \times 10^4$
N-m	8.850	0.737	141.612	1	10.197	0.102	$1.019 \times 10^4$	$1 \times 10^7$
kg-cm	0.8679	$7.233 \times 10^{-2}$	13.877	$9.806 \times 10^{-2}$	1	$10^{-2}$	1000	$9.806 \times 10^5$
kg-m	86.796	7.233	$1.388 \times 10^3$	9.806	100	1	$1 \times 10^5$	$9.806 \times 10^7$
gm-cm	$8.679 \times 10^{-4}$	$7.233 \times 10^{-5}$	$1.388 \times 10^{-2}$	$9.806 \times 10^{-5}$	$1 \times 10^{-3}$	$1 \times 10^{-5}$	1	980.665
dyne-cm	$8.850 \times 10^{-7}$	$7.375 \times 10^{-8}$	$1.416 \times 10^{-5}$	$10^{-7}$	$1.0197 \times 10^{-6}$	$1.019 \times 10^{-8}$	$1.019 \times 10^{-3}$	1

#### Length (to convert from A to B, multiply by entry in table)

A \ B	inches	feet	cm	yd	mm	m
inches	1	0.0833	2.54	0.028	25.4	0.0254
feet	12	1	30.48	0.333	304.8	0.3048
cm	0.3937	0.03281	1	$1.09 \times 10^{-2}$	10	0.01
yd	36	3	91.44	1	914.4	0.914
mm	0.03937	0.00328	0.1	$1.09 \times 10^{-3}$	1	0.001
m	39.37	3.281	100	1.09	1000	1

#### Force (to convert from A to B, multiply by entry in table)

A \ B	lb	oz	gm	dyne	N
lb	1	16	453.6	$4.448 \times 10^5$	4.4482
oz	0.0625	1	28.35	$2.780 \times 10^4$	0.27801
gm	$2.205 \times 10^{-3}$	0.03527	1	$1.02 \times 10^{-3}$	N.A.
dyne	$2.248 \times 10^{-6}$	$3.59 \times 10^{-5}$	980.7	1	0.00001
N	0.22481	3.5967	N.A.	100000	1

#### Mass (to convert from A to B, multiply by entry in table)

A \ B	lb	oz	gm	kg	slug
lb	1	16	453.6	0.4536	0.0311
oz	$6.25 \times 10^{-2}$	1	28.35	0.02835	$1.93 \times 10^{-3}$
gm	$2.205 \times 10^{-3}$	$3.527 \times 10^{-2}$	1	$10^{-3}$	$6.852 \times 10^{-5}$
kg	2.205	35.27	$10^3$	1	$6.852 \times 10^{-2}$
slug	32.17	514.8	$1.459 \times 10^4$	14.59	1

#### Rotation (to convert from A to B, multiply by entry in table)

A \ B	rpm	rad/s	degrees/s
rpm	1	0.105	6.0
rad/s	9.55	1	57.30
degrees/s	0.167	$1.745 \times 10^{-2}$	1

#### Power (to convert from A to B, multiply by entry in table)

A \ B	hp	Watts
hp (English)	1	745.7
(lb-in) (deg./s)	$2.645 \times 10^{-6}$	$1.972 \times 10^{-3}$
(lb-in) (rpm)	$1.587 \times 10^{-5}$	$1.183 \times 10^{-2}$
(lb-ft) (deg./s)	$3.173 \times 10^{-5}$	$2.366 \times 10^{-2}$
(lb-ft) (rpm)	$1.904 \times 10^{-4}$	0.1420
Watts	$1.341 \times 10^{-3}$	1

**Temperature Conversion**

°F	°C	°C	°F
0	-17.8	-10	14
32	0	0	32
50	10	10	50
70	21.1	20	68
90	32.2	30	86
98.4	37	37	98.4
212	100	100	212
subtract 32 and multiply by $\frac{5}{9}$		multiply by $\frac{9}{5}$ and add 32	

**Mechanism Efficiencies**

Acme-screw with brass nut	~0.35–0.65
Acme-screw with plastic nut	~0.50–0.85
Ball-screw	~0.85–0.95
Chain and sprocket	~0.95–0.98
Preloaded ball-screw	~0.75–0.85
Spur or bevel-gears	~0.90
Timing belts	~0.96–0.98
Worm gears	~0.45–0.85
Helical gear (1 reduction)	~0.92

**Friction Coefficients**

Materials	$\mu$
Steel on steel (greased)	~0.15
Plastic on steel	~0.15–0.25
Copper on steel	~0.30
Brass on steel	~0.35
Aluminum on steel	~0.45
Steel on steel	~0.58
Mechanism	$\mu$
Ball bushings	<0.001
Linear bearings	<0.001
Dove-tail slides	~0.2++
Gibb ways	~0.5++

**Material Densities**

Material	lb-in <sup>3</sup>	gm-cm <sup>3</sup>
Aluminum	0.096	2.66
Brass	0.299	8.30
Bronze	0.295	8.17
Copper	0.322	8.91
Hard wood	0.029	0.80
Soft wood	0.018	0.48
Plastic	0.040	1.11
Glass	0.079–0.090	2.2–2.5
Titanium	0.163	4.51
Paper	0.025–0.043	0.7–1.2
Polyvinyl chloride	0.047–0.050	1.3–1.4
Rubber	0.033–0.036	0.92–0.99
Silicone rubber, without filler	0.043	1.2
Cast iron, gray	0.274	7.6
Steel	0.280	7.75

**Wire Gauges<sup>1)</sup>**

Cross-section mm <sup>2</sup>	Standard Wire Gauge (SWG)	American Wire Gauge (AWG)
0.2	25	24
0.3	23	22
0.5	21	20
0.75	20	19
1.0	19	18
1.5	17	16
2.5	15	13
4	13	11
6	12	9
10	9	7
16	7	6
25	5	3
35	3	2
50	0	1/0
70	000	2/0
95	00000	3/0
120	0000000	4/0
150	–	6/0
185	–	7/0

<sup>1)</sup> The table shows approximate SWG/AWG sizes nearest to standard metric sizes; the cross-sections do not match exactly.

## Appendix

### Metal surcharges

#### Explanation of the raw material/metal surcharges <sup>1)</sup>

##### Surcharge calculation

To compensate for variations in the price of the raw materials silver, copper, aluminum, lead, gold, dysprosium <sup>2)</sup> and/or neodym <sup>2)</sup>, surcharges are calculated on a daily basis using the so-called metal factor for products containing these raw materials. A surcharge for the respective raw material is calculated as a supplement to the price of a product if the basic official price of the raw material in question is exceeded.

The surcharges are calculated in accordance with the following criteria:

- Basic official price of the raw material  
Basic official price from the day prior to receipt of the order or prior to release order (daily price) for <sup>3)</sup>  
- Silver (sales price, processed)  
- Gold (sales price, processed)  
and for <sup>4)</sup>  
- Copper (lower DEL notation + 1 %)  
- Aluminum (aluminum in cables)  
- Lead (lead in cables)
- Metal factor of the products  
Certain products are displayed with a metal factor. The metal factor determines the official price (for those raw materials concerned) as of which the metal surcharges are applied and the calculation method used (weight or percentage method). An exact explanation is given below.

##### Structure of the metal factor

The metal factor consists of several digits; the first digit indicates whether the percentage method of calculation refers to the list price or a possible discounted price (customer net price) (L = list price / N = customer net price).

The remaining digits indicate the method of calculation used for the respective raw material. If no surcharge is added for a raw material, a "-" is used.

1st digit	List or customer net price using the percentage method
2nd digit	for silver (AG)
3rd digit	for copper (CU)
4th digit	for aluminum (AL)
5th digit	for lead (PB)
6th digit	for gold (AU)
7th digit	for dysprosium (Dy) <sup>2)</sup>
8th digit	for neodym (Nd) <sup>2)</sup>

##### Weight method

The weight method uses the basic official price, the daily price and the raw material weight. In order to calculate the surcharge, the basic official price must be subtracted from the daily price. The difference is then multiplied by the raw material weight.

The basic official price can be found in the table below using the number (1 to 9) of the respective digit of the metal factor. The raw material weight can be found in the respective product descriptions.

##### Percentage method

Use of the percentage method is indicated by the letters A-Z at the respective digit of the metal factor.

The surcharge is increased - dependent on the deviation of the daily price compared with the basic official price - using the percentage method in "steps" and consequently offers surcharges that remain constant within the framework of this "step range". A higher percentage rate is charged for each new step. The respective percentage level can be found in the table below.

##### Metal factor examples

<b>L E A</b> - - - -	<ul style="list-style-type: none"> <li>Basis for % surcharge: List price</li> <li>Silver Basis 150 €, Step 50 €, 0.5 %</li> <li>Copper Basis 150 €, Step 50 €, 0.1 %</li> <li>No surcharge for aluminum</li> <li>No surcharge for lead</li> <li>No surcharge for gold</li> <li>No surcharge for dysprosium</li> <li>No surcharge for neodym</li> </ul>
<b>N - A 6</b> - - - -	<ul style="list-style-type: none"> <li>Basis for % surcharge: Customer net price</li> <li>No surcharge for silver</li> <li>Copper Basis 150 €, Step 50 €, 0.1 %</li> <li>Aluminum acc. to weight, basic offic. price 225 €</li> <li>No surcharge for lead</li> <li>No surcharge for gold</li> <li>No surcharge for dysprosium</li> <li>No surcharge for neodym</li> </ul>
- - <b>3</b> - - - -	<ul style="list-style-type: none"> <li>No basis necessary</li> <li>No surcharge for silver</li> <li>Copper acc. to weight, basic official price 150 €</li> <li>No surcharge for aluminum</li> <li>No surcharge for lead</li> <li>No surcharge for gold</li> <li>No surcharge for dysprosium</li> <li>No surcharge for neodym</li> </ul>

1) Refer to the separate explanation on the next page regarding the raw materials dysprosium and neodym (= rare earths).

2) For a different method of calculation, refer to the separate explanation for these raw materials on the next page.

3) Source: Umicore, Hanau ([www.metalsmanagement.umicore.com](http://www.metalsmanagement.umicore.com)).

4) Source: Schutzvereinigung DEL-Notiz e.V. ([www.del-notiz.org](http://www.del-notiz.org)).



## Explanation of the raw material/metal surcharges for dysprosium and neodym (rare earths)

### Surcharge calculation

To compensate for variations in the price of the raw materials silver <sup>1)</sup>, copper <sup>1)</sup>, aluminum <sup>1)</sup>, lead <sup>1)</sup>, gold <sup>1)</sup>, dysprosium and/or neodym, surcharges are calculated on a daily basis using the so-called metal factor for products containing these raw materials. The surcharge for dysprosium and neodym is calculated as a supplement to the price of a product if the basic official price of the raw material in question is exceeded.

The surcharge is calculated in accordance with the following criteria:

- Basic official price of the raw material <sup>2)</sup>  
Three-month basic average price (see below) in the period before the quarter in which the order was received or the release order took place (= average official price) for  
- dysprosium (Dy metal, 99 % min. FOB China; USD/kg)  
- neodym (Nd metal, 99 % min. FOB China; USD/kg)
- Metal factor of the products  
Certain products are displayed with a metal factor. The metal factor indicates (for those raw materials concerned) the basic official price as of which the surcharges for dysprosium and neodym are calculated using the weight method. An exact explanation of the metal factor is given below.

### Three-month average price

The prices of rare earths vary according to the foreign currency, and there is no freely accessible stock exchange listing. This makes it more difficult for all parties involved to monitor changes in price. In order to avoid continuous adjustment of the surcharges, but to still ensure fair, transparent pricing, an average price is calculated over a three-month period using the average monthly foreign exchange rate from USD to EUR (source: European Central Bank). Since not all facts are immediately available at the start of each month, a one-month buffer is allowed before the new average price applies.

Examples of calculation of the average official price:

Period for calculation of the average price:	Period during which the order/release order is effected and the average price applies:
Sep 2012 - Nov 2012	Q1 in 2013 (Jan - Mar)
Dec 2012 - Feb 2013	Q2 in 2013 (Apr - Jun)
Mar 2013 - May 2013	Q3 in 2013 (Jul - Sep)
Jun 2013 - Aug 2013	Q4 in 2013 (Oct - Dec)

### Structure of the metal factor

The metal factor consists of several digits; the first digit is not relevant to the calculation of dysprosium and neodym.

The remaining digits indicate the method of calculation used for the respective raw material. If no surcharge is added for a raw material, a "-" is used.

1st digit	List or customer net price using the percentage method
2nd digit	for silver (AG) <sup>1)</sup>
3rd digit	for copper (CU) <sup>1)</sup>
4th digit	for aluminum (AL) <sup>1)</sup>
5th digit	for lead (PB) <sup>1)</sup>
6th digit	for gold (AU) <sup>1)</sup>
7th digit	for dysprosium (Dy)
8th digit	for neodym (Nd)

### Weight method

The weight method uses the basic official price, the average price and the raw material weight. In order to calculate the surcharge, the basic official price must be subtracted from the average price. The difference is then multiplied by the raw material weight.

The basic official price can be found in the table below using the number (1 to 9) of the respective digit of the metal factor. Your Sales contact can inform you of the raw material weight.

### Metal factor examples

-----71	No basis necessary
↑	No surcharge for silver
↑	No surcharge for copper
↑	No surcharge for aluminum
↑	No surcharge for lead
↑	No surcharge for gold
↑	Dysprosium acc. to weight, basic official price 300 €
↑	Neodym acc. to weight, basic official price 50 €

1) For a different method of calculation, refer to the separate explanation for these raw materials on the previous page.

2) Source: Asian Metal Ltd ([www.asianmetal.com](http://www.asianmetal.com))

## Appendix

### Metal surcharges

#### Values of the metal factor

Percentage method	Basic official price in €	Step range in €	% surcharge 1st step	% surcharge 2nd step	% surcharge 3rd step	% surcharge 4th step	% surcharge per additional step	
			Price in €	Price in €	Price in €	Price in €		
			150.01 - 200.00	200.01 - 250.00	250.01 - 300.00	300.01 - 350.00		
A	150	50	0.1	0.2	0.3	0.4	0.1	
B	150	50	0.2	0.4	0.6	0.8	0.2	
C	150	50	0.3	0.6	0.9	1.2	0.3	
D	150	50	0.4	0.8	1.2	1.6	0.4	
E	150	50	0.5	1.0	1.5	2.0	0.5	
F	150	50	0.6	1.2	1.8	2.4	0.6	
G	150	50	1.0	2.0	3.0	4.0	1.0	
H	150	50	1.2	2.4	3.6	4.8	1.2	
I	150	50	1.6	3.2	4.8	6.4	1.6	
J	150	50	1.8	3.6	5.4	7.2	1.8	
			175.01 - 225.00	225.01 - 275.00	275.01 - 325.00	325.01 - 375.00		
O	175	50	0.1	0.2	0.3	0.4	0.1	
P	175	50	0.2	0.4	0.6	0.8	0.2	
R	175	50	0.5	1.0	1.5	2.0	0.5	
			225.01 - 275.00	275.01 - 325.00	325.01 - 375.00	375.01 - 425.00		
S	225	50	0.2	0.4	0.6	0.8	0.2	
U	225	50	1.0	2.0	3.0	4.0	1.0	
V	225	50	1.0	1.5	2.0	3.0	1.0	
W	225	50	1.2	2.5	3.5	4.5	1.0	
			150.01 - 175.00	175.01 - 200.00	200.01 - 225.00	225.01 - 250.00		
Y	150	25	0.3	0.6	0.9	1.2	0.3	
			400.01 - 425.00	425.01 - 450.00	450.01 - 475.00	475.01 - 500.00		
Z	400	25	0.1	0.2	0.3	0.4	0.1	
<b>Price basis (1st digit)</b>								
L	Calculation based on the list price							
N	Calculation based on the customer net price (discounted list price)							
<b>Weight method</b>	<b>Basic official price in €</b>							
1	50	Calculation based on raw material weight						
2	100							
3	150							
4	175							
5	200							
6	225							
7	300							
8	400							
9	555							
<b>Miscellaneous</b>								
-	No metal surcharge							

## 1. General Provisions

By using this catalog you can acquire hardware and software products described therein from Siemens AG subject to the following Terms and Conditions of Sale and Delivery (hereinafter referred to as "T&C"). Please note that the scope, the quality and the conditions for supplies and services, including software products, by any Siemens entity having a registered office outside Germany, shall be subject exclusively to the General Terms and Conditions of the respective Siemens entity. The following T&C apply exclusively for orders placed with Siemens Aktiengesellschaft, Germany.

### 1.1 For customers with a seat or registered office in Germany

For customers with a seat or registered office in Germany, the following applies subordinate to the T&C:

- for installation work the "General Conditions for Erection Works – Germany"<sup>1)</sup> ("Allgemeine Montagebedingungen – Deutschland" (only available in German at the moment)) and/or
- for Plant Analytics Services the "Standard Terms and Conditions for Plant Analytics Services – for Customer in Germany"<sup>1)</sup> ("Allgemeine Geschäftsbedingungen für das Plant Analytics Services – für Kunden in Deutschland" (only available in German at the moment)) and/or
- for stand-alone software products and software products forming a part of a product or project, the "General License Conditions for Software Products for Automation and Drives for Customers with a Seat or registered Office in Germany"<sup>1)</sup> and/or
- for other supplies and/or services the "General Conditions for the Supply of Products and Services of the Electrical and Electronics Industry"<sup>1)</sup>.

In case such supplies and/or services should contain Open Source Software, the conditions of which shall prevail over the "General Conditions for the Supply of Products and Services of the Electrical and Electronics Industry"<sup>1)</sup>. A notice will be contained in the scope of delivery in which the applicable conditions for Open Source Software are specified. This shall apply mutatis mutandis for notices referring to other third party software components.

### 1.2 For customers with a seat or registered office outside Germany

For customers with a seat or registered office outside Germany, the following applies subordinate to the T&C:

- for Plant Analytics Services the "Standard Terms and Conditions for Plant Analytics Services"<sup>1)</sup> and/or
- for services the "International Terms & Conditions for Services"<sup>1)</sup> supplemented by "Software Licensing Conditions"<sup>1)</sup> and/or
- for other supplies of hard- and/or software the "International Terms & Conditions for Products"<sup>1)</sup> supplemented by "Software Licensing Conditions"<sup>1)</sup>

### 1.3 For customers with master or framework agreement

To the extent our supplies and/or services offered are covered by an existing master or framework agreement, the terms and conditions of that agreement shall apply instead of T&C.

## 2. Prices

The prices are in € (Euro) ex point of delivery, exclusive of packaging.

The sales tax (value added tax) is not included in the prices. It shall be charged separately at the respective rate according to the applicable statutory legal regulations.

Prices are subject to change without prior notice. We will charge the prices valid at the time of delivery.

To compensate for variations in the price of raw materials (e.g. silver, copper, aluminum, lead, gold, dysprosium and neodym), surcharges are calculated on a daily basis using the so-called metal factor for products containing these raw materials. A surcharge for the respective raw material is calculated as a supplement to the price of a product if the basic official price of the raw material in question is exceeded.

The metal factor of a product indicates the basic official price (for those raw materials concerned) as of which the surcharges on the price of the product are applied, and with what method of calculation.

You will find a detailed explanation of the metal factor on the page headed "Metal surcharges".

To calculate the surcharge (except in the cases of dysprosium and neodym), the official price from the day prior to that on which the order was received or the release order was effected is used.

To calculate the surcharge applicable to dysprosium and neodym ("rare earths"), the corresponding three-month basic average price in the quarter prior to that in which the order was received or the release order was effected is used with a one-month buffer (details on the calculation can be found in the explanation of the metal factor).

## 3. Additional Terms and Conditions

The dimensions are in mm. In Germany, according to the German law on units in measuring technology, data in inches apply only to devices for export.

Illustrations are not binding.

Insofar as there are no remarks on the individual pages of this catalog - especially with regard to data, dimensions and weights given - these are subject to change without prior notice.

<sup>1)</sup> The text of the Terms and Conditions of Siemens AG can be downloaded at [www.siemens.com/automation/salesmaterial-as/catalog/en/terms\\_of\\_trade\\_en.pdf](http://www.siemens.com/automation/salesmaterial-as/catalog/en/terms_of_trade_en.pdf)

## Appendix

### Conditions of sale and delivery

#### 4. Export regulations

We shall not be obligated to fulfill any agreement if such fulfillment is prevented by any impediments arising out of national or international foreign trade or customs requirements or any embargoes and/or other sanctions.

Export may be subject to license. We shall indicate in the delivery details whether licenses are required under German, European and US export lists.

Our products are controlled by the U.S. Government (when labeled with "ECCN" unequal "N") and authorized for export only to the country of ultimate destination for use by the ultimate consignee or end-user(s) herein identified. They may not be resold, transferred, or otherwise disposed of, to any other country or to any person other than the authorized ultimate consignee or end-user(s), either in their original form or after being incorporated into other items, without first obtaining approval from the U.S. Government or as otherwise authorized by U.S. law and regulations.

The export indications can be viewed in advance in the description of the respective goods on the Industry Mall, our online catalog system. Only the export labels "AL" and "ECCN" indicated on order confirmations, delivery notes and invoices are authoritative.

Products labeled with "AL" unequal "N" are subject to European / national export authorization. Products without label, with label "AL:N" / "ECCN:N", or label "AL:9X9999" / "ECCN: 9X9999" may require authorization from responsible authorities depending on the final end-use, or the destination.

If you transfer goods (hardware and/or software and/or technology as well as corresponding documentation, regardless of the mode of provision) delivered by us or works and services (including all kinds of technical support) performed by us to a third party worldwide, you must comply with all applicable national and international (re-)export control regulations.

If required for the purpose of conducting export control checks, you (upon request by us) shall promptly provide us with all information pertaining to the particular end customer, final disposition and intended use of goods delivered by us respectively works and services provided by us, as well as to any export control restrictions existing in this relation.

The products listed in this catalog may be subject to European/German and/or US export regulations. Any export requiring approval is therefore subject to authorization by the relevant authorities.

Errors excepted and subject to change without prior notice.

## Selection and ordering at Siemens Industry Mall, Catalog CA 01, downloading and ordering catalogs

### Easy product selection and ordering: Industry Mall and Interactive Catalog CA 01

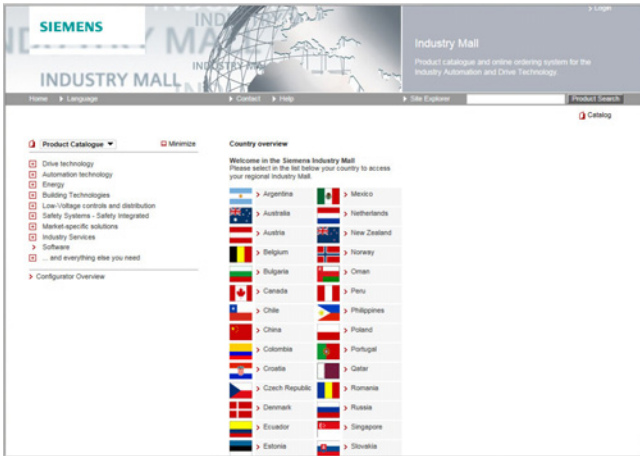

#### Industry Mall

The Industry Mall is a Siemens AG Internet ordering platform. It provides you with online access to a comprehensive product spectrum that is presented in an informative, well-organized way.

Powerful search functions help you select the required products, while configurators enable you to configure complex product and system components quickly and easily. CAx data are also available for you to use.

Data transfer allows the entire procedure, from selection through ordering to tracking and tracing, to be carried out online. Availability checks, individual customer discounting, and quotation preparation are also possible.

[www.siemens.com/industrymall](http://www.siemens.com/industrymall)



#### Interactive Catalog CA 01 – Products for automation and drives

The Interactive Catalog CA 01 combined with the Siemens Industry Mall unites the benefits of offline and online media in one application – the performance of an offline catalog with the availability of a wide range of up-to-date information on the Internet.

Select products and assemble orders using the CA 01, determine the availability of the selected products, and track and trace them via the Industry Mall.

Information and download:

[www.siemens.com/automation/ca01](http://www.siemens.com/automation/ca01)

### Downloading catalogs

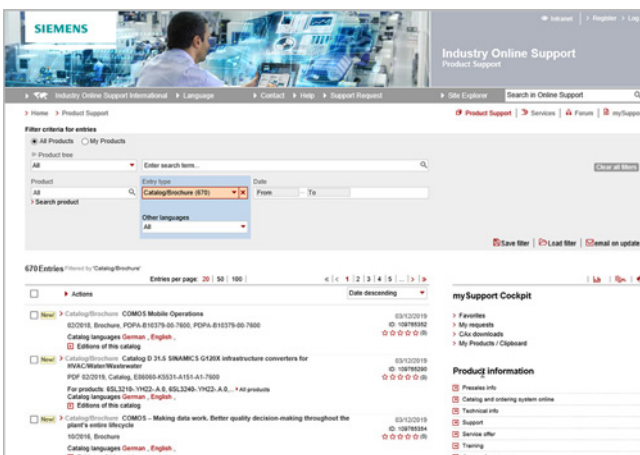

#### Siemens Industry Online Support

You can download catalogs and brochures in PDF format from Siemens Industry Online Support without having to register.

The filter box makes it possible to perform targeted searches.

[www.siemens.com/industry-catalogs](http://www.siemens.com/industry-catalogs)

### Ordering printed catalogs



Please contact your local Siemens branch if you are interested in ordering printed catalogs.

Addresses can be found at

[www.siemens.com/automation-contact](http://www.siemens.com/automation-contact)

## Get more information

The SINAMICS drives family:  
[www.siemens.com/sinamics](http://www.siemens.com/sinamics)

SIMOTICS electric motors:  
[www.siemens.com/simotics](http://www.siemens.com/simotics)

Motion Control Systems and Solutions for production machine and machine tool equipment:  
[www.siemens.com/motioncontrol](http://www.siemens.com/motioncontrol)

Local partners worldwide:  
[www.siemens.com/automation-contact](http://www.siemens.com/automation-contact)

Published by  
Siemens AG

For the U.S. published by  
Siemens Industry Inc.

Digital Industries  
Motion Control  
Postfach 31 80  
91050 Erlangen, Germany

5300 Triangle Parkway  
Norcross, GA 30092  
United States

PDF (Article No. E86060-K5533-A101-A2-7600)  
V6.MKKATA.GMC.180  
KG 0519 78 En  
Produced in Germany  
© Siemens 2019

Subject to changes and errors. The information given in this document only contains general descriptions and/or performance features which may not always specifically reflect those described, or which may undergo modification in the course of further development of the products. The requested performance features are binding only when they are expressly agreed upon in the concluded contract.

All product designations may be trademarks or product names of Siemens AG or other companies whose use by third parties for their own purposes could violate the rights of the owners.

## Security information

Siemens provides products and solutions with industrial security functions that support the secure operation of plants, systems, machines and networks.

In order to protect plants, systems, machines and networks against cyber threats, it is necessary to implement – and continuously maintain – a holistic, state-of-the-art industrial security concept. Siemens' products and solutions constitute one element of such a concept.

Customers are responsible for preventing unauthorized access to their plants, systems, machines and networks. Such systems, machines and components should only be connected to an enterprise network or the internet if and to the extent such a connection is necessary and only when appropriate security measures (e.g. firewalls and/or network segmentation) are in place.

For additional information on industrial security measures that may be implemented, please visit  
<https://www.siemens.com/industrialsecurity>

Siemens' products and solutions undergo continuous development to make them more secure. Siemens strongly recommends that product updates are applied as soon as they are available and that the latest product versions are used. Use of product versions that are no longer supported, and failure to apply the latest updates may increase customer's exposure to cyber threats.

To stay informed about product updates, subscribe to the Siemens Industrial Security RSS Feed under  
<https://www.siemens.com/industrialsecurity>