

SH. 1  
OF 1

CAT NO

436.1XRLZ-22

CUSTOMER DIMENSIONS

DO NOT  
SEPARATE  
PRINT FROM  
WORK

LOT NO

OPER

TOOLS

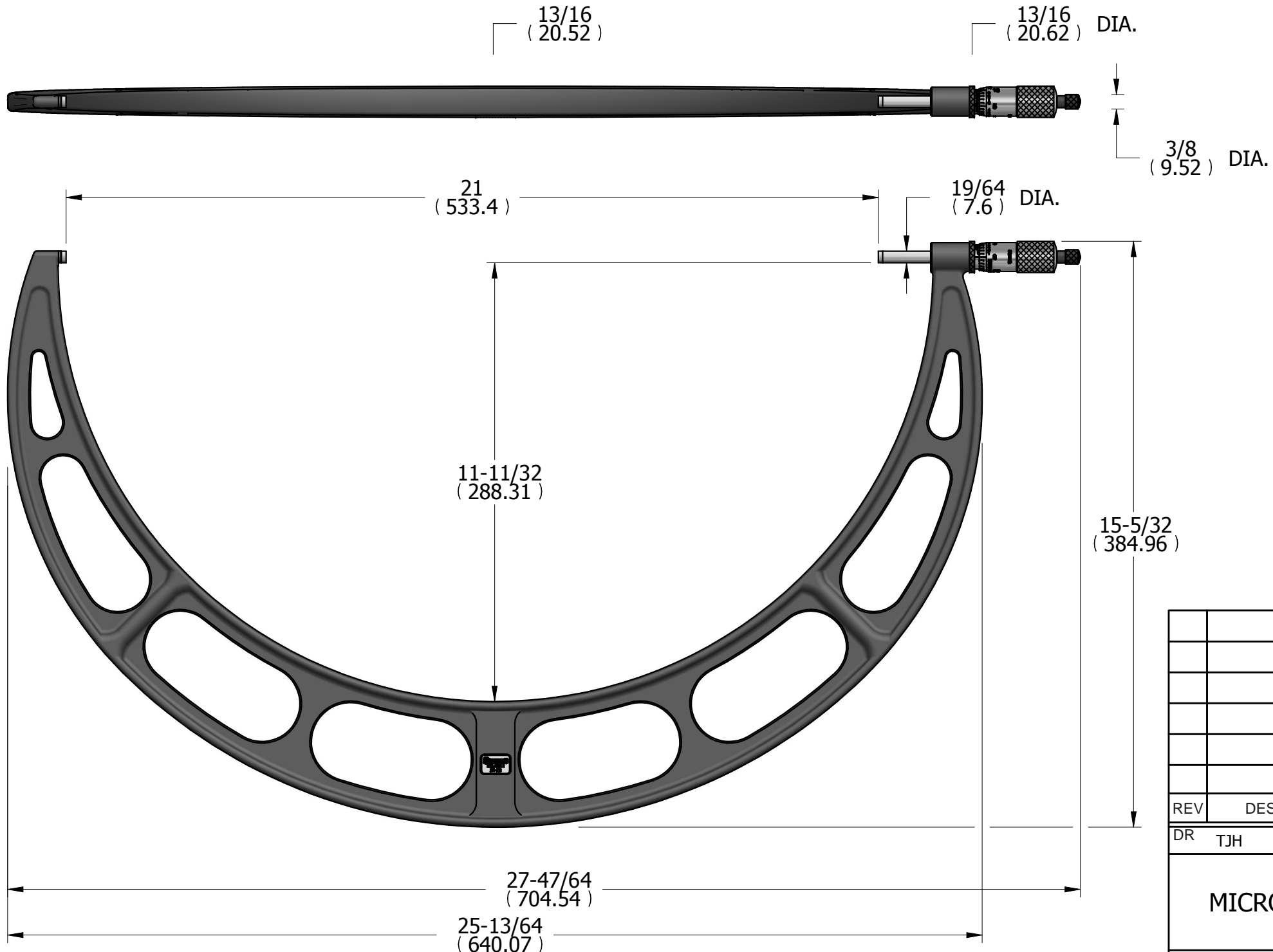

REV	DESCRIPTION	DATE	BY
DR	TJH	CHK	DATE 6/29/15

MICROMETER CALIPER

THE L.S. STARRETT CO.  
ATHOL, MASS.

FRACTIONAL TOLERANCE +/- 1/64 UNLESS OTHERWISE NOTED