



Saw Blade Lube Systems

Cutting Edge Technology

Cutting Edge Technology

Unist saw blade lubrication systems deliver all the benefits of Minimum Quantity Lubrication (MQL) to your band or circular saw in a durable, easy-to-install package. Longer lasting blades, better cut quality, fluid savings, and clean, dry chips are just a few of the reasons people love our systems and Coolube® lubricant.

If you're currently using flood coolant on your saw, switching to a Unist saw blade lubrication system will completely eliminate the need for coolant, alleviating the health and safety concerns it creates as well as the ongoing costs of treatment and disposal.

Unist offers numerous system options to make sure your saw blade lubrication system is perfect for your application and we'll work with you to make sure your system is a success. Get started enjoying the benefits of MQL on your saw today!



- Eliminate the mess of traditional flood coolant systems
- Save money with reduced fluid usage

- Extend blade life & reduce downtime
- Dry chips are worth more money when recycled

MQL: A Better Way To Saw

Minimum Quantity Lubrication (MQL) replaces the flood coolant commonly used in sawing operations with a minute amount of high-quality lubricant precisely applied to the saw blade. The lubricant minimizes friction between the stock and the blade, greatly reducing the heat that is generated during sawing. In contrast, the purpose of traditional flood coolant is to absorb the heat after it has been created. MQL technology has been used for over 25 years and has proven its effectiveness in a broad range of sawing operations.



 Sawing with coolant



 Sawing with MQL

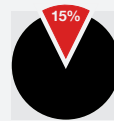

Coolant = Up to 15% of machining costs!

The cost of dealing with flood coolants, including mixing, treatment, circulation, and disposal can account for up to 15% of total machining costs.

Why Use MQL?

Many of the benefits of MQL are a direct result of eliminating flood coolant and the issues it creates. Studies have shown that the cost of dealing with flood coolants, including mixing, treatment, circulation, and disposal can account for up to 15% of total sawing costs. Additionally, splashing coolant often coats equipment and surrounding areas, negatively affecting saw reliability and creating hazardous, slippery floors.

In contrast to using flood coolant, an MQL applicator dispenses environmentally friendly lubricant in such minute amounts that it is often consumed in the process. This leaves little or no excess fluid to clean up or dispose of, and the chips produced are dry enough to be recycled without additional processing.

Images courtesy of Unist customer sawing 3" Inconel bar stock. Both cuts were made running at the same speed and feed.

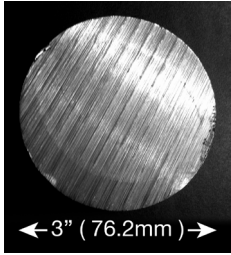

Cut with coolant

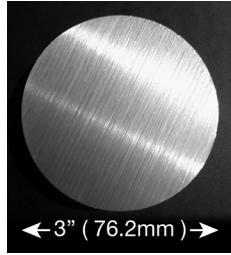

Cut with Unist Coolube®

Improved Results Sawing With Unist

The photo on the left shows cut quality before the Unist system was added. This cut was made using flood coolant and shows excessive chatter and a large burr on the edge of the stock. The photo on the right shows the same material cut with an identical blade after a Unist system was installed. The cut was made using our Coolube® lubricant. Not only was the cut quality greatly improved, but blade life increased substantially! This customer was able to eliminate the cost and mess of flood coolant and also saves considerably on blade costs.

Precision Fluid Application

Precise fluid application is the key to maximizing the benefits of Minimum Quantity Lubrication. Applying too much lubricant is a waste and can adversely affect chip formation, whereas inadequate lubricant reduces blade life. Precise fluid application requires accurate pumps for consistent lubricant delivery and appropriate nozzles to create and direct the spray.

The adjustable positive displacement pumps used in our systems have a proven track record of consistency and reliability. Each pump module includes a stroke adjustment for the pump output and a precise metering screw for the nozzle air flow. The combination of these adjustments provides complete control of the spray output.

Although supplying the perfect amount of fluid is important, it doesn't do any good unless it is properly delivered to the cutting tool/work piece interface. To make this possible, Unist has developed several nozzles to precisely apply the lubricant in nearly any metal sawing operation.



Easily adjust cycle rate, pump stroke, and air flow for the perfect spray.

Typical Saw Blade Lube System

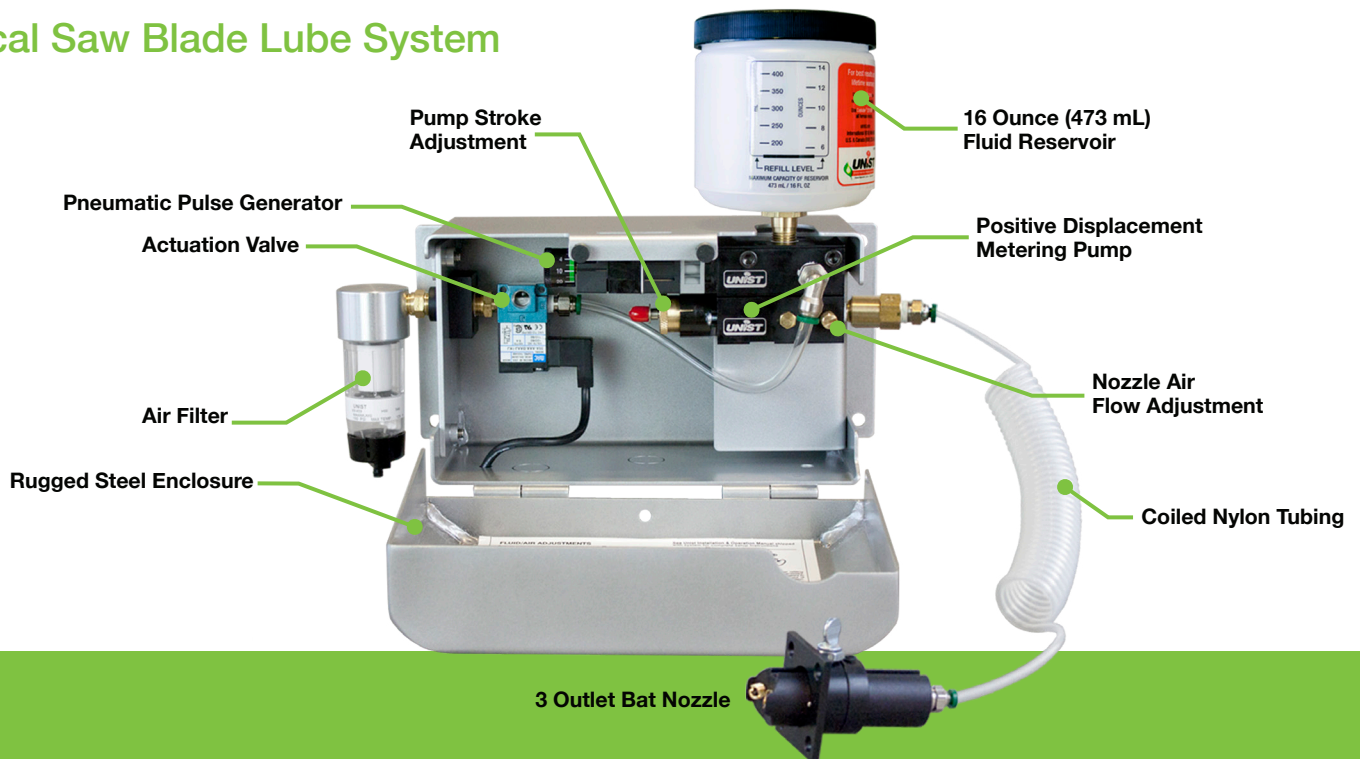

Saw Blade Lube Systems *Cutting Edge Technology*

Saw Blade Lube Systems & Coolube®

Maximize the benefits of sawing with MQL by filling your system reservoir with Unist Coolube®. Coolube® is a 100% natural biodegradable lubricant derived from renewable vegetable products that is friendly to the environment and operators. When applied properly, Coolube® is completely consumed in the sawing process and the mess of traditional flood coolant is eliminated. As an added benefit, when a saw blade lube system is used exclusively with Coolube®, Unist guarantees the pumps forever!

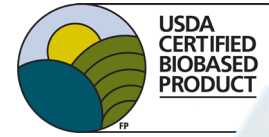

*Coolube® is a
USDA certified
biobased product*



Saw Nozzle Options

Circular & Band Saw Nozzle

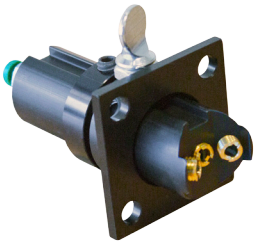

Bat Nozzle

The Bat Nozzle was designed to easily fit on a wide variety of circular saws, vertical band saws, and horizontal band saws. The nozzle includes a 1.75" (44.5 mm) square mounting flange that can be attached to the blade guard. A 1" (25.4 mm) diameter hole drilled through the guard allows the nozzle to be centered over the blade. The nozzle position can then be adjusted as close to the blade as required with a thumb screw. Two outlets on the sides of the blade and a third outlet spraying directly into the gullet of the teeth assure proper application of lubricant to the saw blade. The Bat Nozzle is available in various lengths to accommodate a broad range of saws.

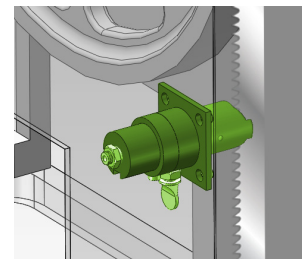
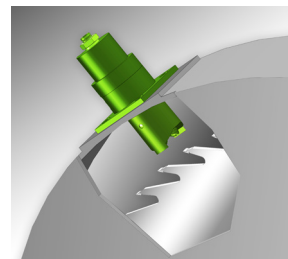
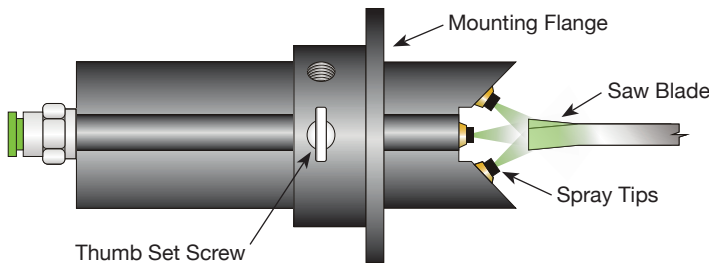

Easily mount a Bat Nozzle to a circular saw or band saw.

Bat Nozzle Ideal For:

- **Circular Saw:** Blade 20" (508 mm) or under
- **Horizontal Band Saw:** All blade sizes
- **Vertical Band Saw:** All blade sizes



Example of easily mounting a Bat Nozzle to a circular saw.



Horizontal Band Saw Nozzles

U Nozzle



The U Nozzle is shaped very similarly to a Bat Nozzle with the cut out in the center extended. Unlike the Bat Nozzle, the U Nozzle is designed to fit around the top of the blade. It sprays down onto the teeth with the two side outputs and lubricates the sides of the blade with the top outlet. The main advantage over the Collapsible Blade Nozzle is it is less sensitive to chip build-up on the bed below the blade. It is often a good idea to use a Guide Nozzle in conjunction with the U Nozzle. It is also important to position the nozzle so the blade is in position to be hit by the output spray. This is .59" (15 mm) below the bottom of the nozzle sides.

The U Nozzle is designed to be used on blades from up to 2" (50.8 mm) but has successfully been used on blades up to 3" (76.2 mm). The nozzle can be mounted to the guide or in the guard before the blade enters the cut.

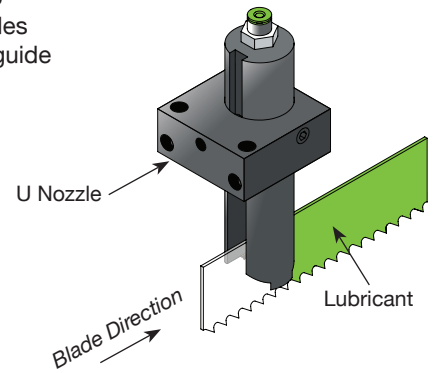
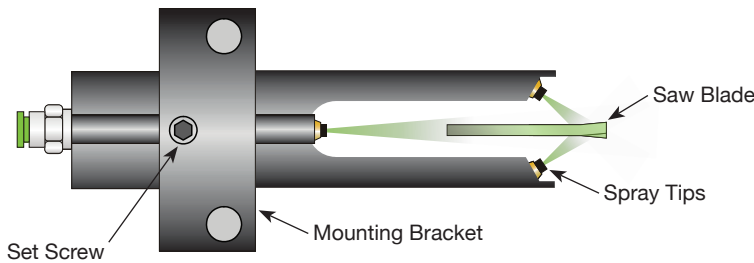

Collapsible Blade Nozzle



The Collapsible Blade Nozzle lubricates the critical points on your saw blade including the teeth, gullet and sides. Our collapsible design straddles the blade with collapsible legs which deliver an atomized spray of lubricant and retract into the nozzle body at the end of the cut. The Collapsible Blade Nozzle can be used in conjunction with our Guide Nozzle on larger blades. It can be mounted to either side of your saw's blade guide to lubricate saw blades up to 3" (76.2 mm) wide.

Mounting kit included

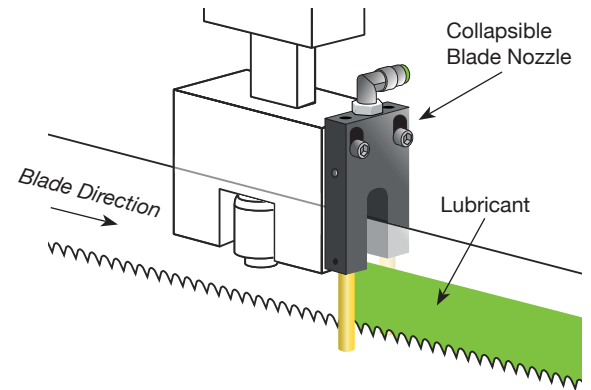

Guide Nozzle



The Guide Nozzle lubricates both sides of the blade prior to entering the blade guide. It is designed to accompany the Collapsible Blade Nozzle on wide blades. The Guide Nozzle applies lubricant to the blade where it comes in contact with the guides to reduce friction and extend blade and guide life.

Mounting kit included

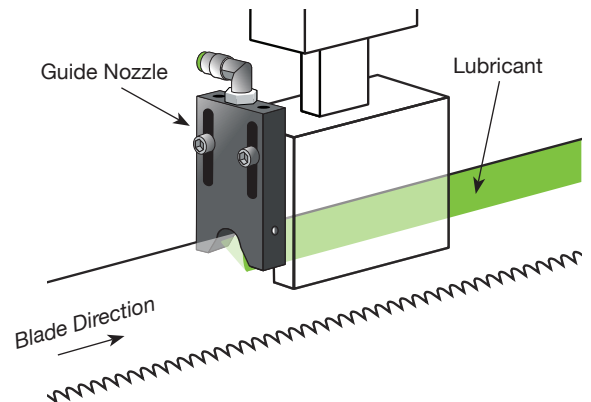

Configuration Options

Multiple Outputs

Operate up to 3 pumps for 3 individual outputs. Outputs can be configured to operate independently or in multiples. Various sized enclosures are available depending on the number of pumps.



1-3 Outlet Enclosure

Air Valve Options

Control saw blade lubrication system operation with the following valve options:

- Solenoid Valve**

For actuation using an electrical signal from the machine



(Available in 24, 110, 220, 440 VAC and 12 or 24 VDC)

- Manual Valve**

3-Way Slide Valve for simple manual on/off control



- Air Pilot Valve**

For use with a low flow air signal



- Foot Valve**

For hands-free manual operation
(Used with air pilot valve)



Pump Options

Choose the appropriate pump output and type for each application.

- Standard 1-Drop Pump**
(0.03 mL per stroke)



- Standard 3-Drop Pump**
(0.10 mL per stroke)



- Multi-Viscosity 1-Drop Pump**
(0.045 mL per stroke)



- Multi-Viscosity 2-Drop Pump**
(0.10 mL per stroke)



The fluid viscosity will determine the type of Unist pump required.

For Coolube® and other fluids between 50 SUS and 1,000 SUS, choose the standard 1 or 3-Drop pump.

For fluids less than 50 SUS, choose the Multi-Viscosity (MV) 1 or 2-Drop pump.

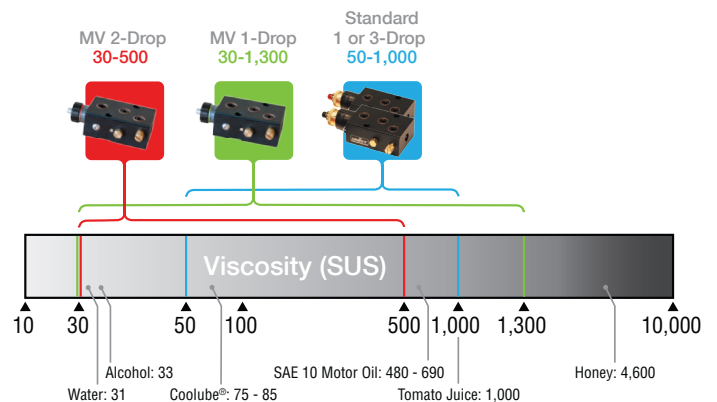

Reservoir Options

A wide variety of fluid reservoirs are available.

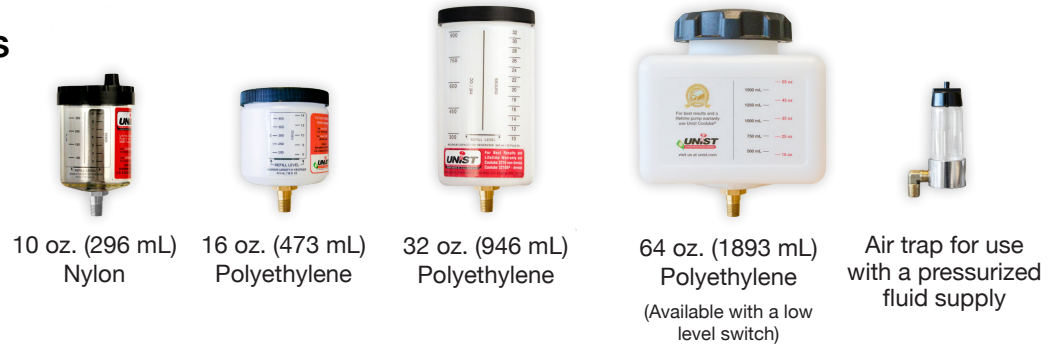

10 oz. (296 mL)
Nylon

16 oz. (473 mL)
Polyethylene

32 oz. (946 mL)
Polyethylene

64 oz. (1893 mL)
Polyethylene
(Available with a low level switch)

Air trap for use with a pressurized fluid supply

Mounting Options

Magnetic mounts are available for both nozzles and system enclosures. The articulated arm mount makes nozzle positioning easy.



Nozzle Mounting Magnets

Enclosure Mounting Magnets

Articulating Arm Mount With Magnetic Base

Enclosure Lock Option

Upgrade from the standard thumb latch to a keyed lock and prevent tampering.



Nozzle Extension Options

Coiled or straight nylon single line tubing is available for connecting nozzles to a saw blade lubrication system. Standard length is 10 feet (3 m). Other lengths are available upon request.



Saw Nozzle Options

Unist has a wide variety of MQL nozzle types to fit each specific sawing application.

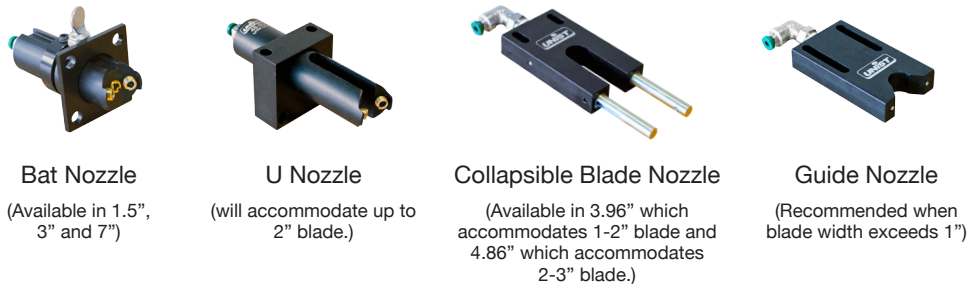

Bat Nozzle
(Available in 1.5", 3" and 7")

U Nozzle
(will accommodate up to 2" blade.)

Collapsible Blade Nozzle
(Available in 3.96" which accommodates 1-2" blade and 4.86" which accommodates 2-3" blade.)

Guide Nozzle
(Recommended when blade width exceeds 1")

Other Nozzle Options

Unist has a wide variety of MQL nozzle types to fit each specific sawing application including stainless steel, copper, flexible plastic and splitter nozzles. Air blow-off nozzle options are also available to aid in chip removal.

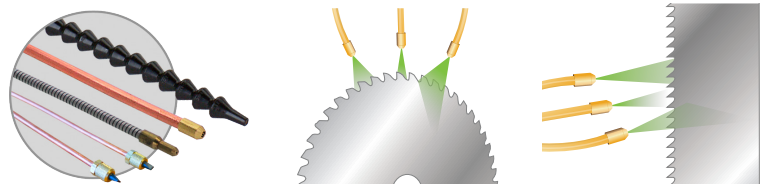

Mounting Kit Dimensions

Mounting Angle

Part Number
302433

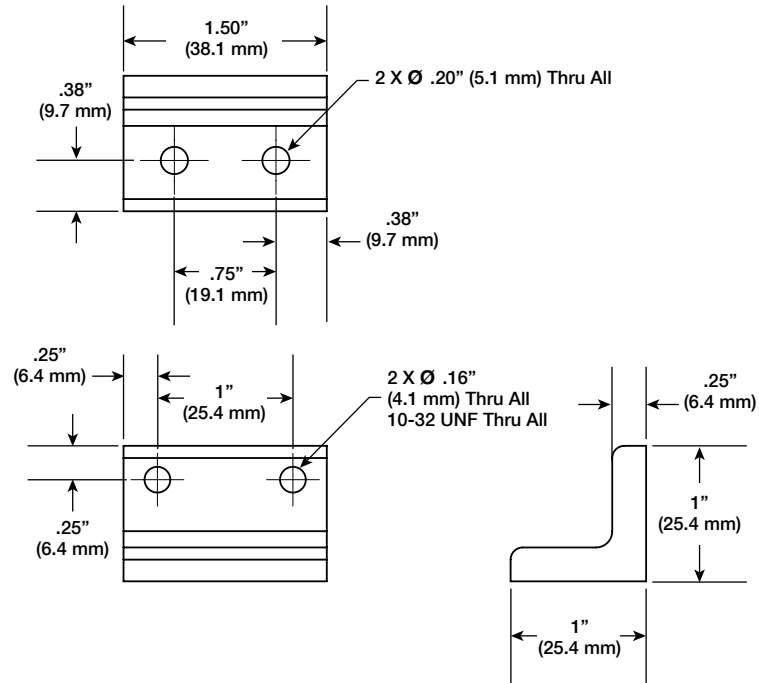

Mounting Plate

Part Number
302432

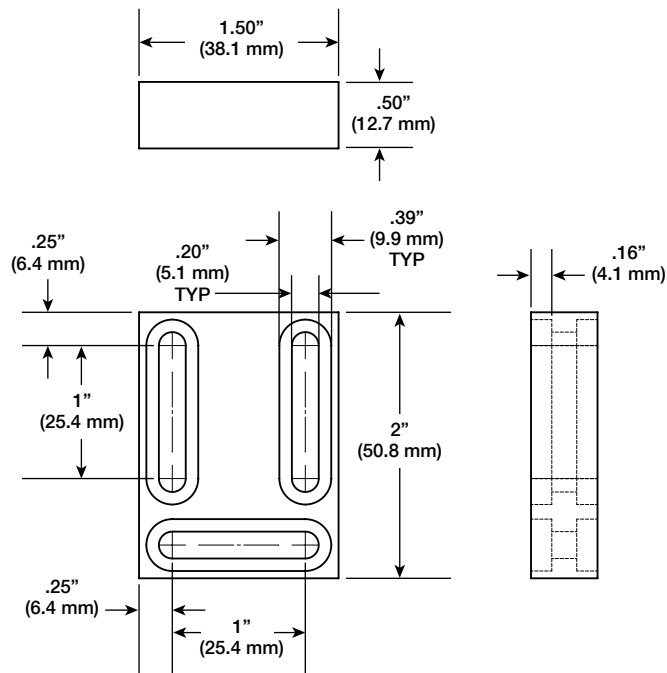

Notes



Unist, Inc.
4134 36th Street SE
Grand Rapids, MI 49512 USA
U.S. & Canada: 800.253.5462
International: 616.949.0853
Email: salessupport@unist.com